

Hypertherm[®]

powermax105[®]

Plasma arc cutting systems



Operator Manual – 807390
Revision 1

Register your new Hypertherm system

Register your product on-line at www.hypertherm.com/registration for easier technical and warranty support. You can also receive updates on new Hypertherm products and a free gift as a token of our appreciation.

For your records

Serial number: _____

Purchase date: _____

Distributor: _____

Maintenance notes:

powermax105

Operator Manual

(P/N 807390)

Revision 1 – June 2012

**Hypertherm, Inc.
Hanover, NH USA
www.hypertherm.com
email: info@hypertherm.com**

**© Copyright 2012 Hypertherm, Inc.
All Rights Reserved**

**Hypertherm and Powermax are trademarks of Hypertherm, Inc.
and may be registered in the United States and/or other countries.**

Hypertherm, Inc.

Etna Road, P.O. Box 5010
Hanover, NH 03755 USA
603-643-3441 Tel (Main Office)
603-643-5352 Fax (All Departments)
info@hypertherm.com (Main Office Email)
800-643-9878 Tel (Technical Service)
technical.service@hypertherm.com (Technical Service Email)
800-737-2978 Tel (Customer Service)
customer.service@hypertherm.com (Customer Service Email)
866-643-7711 Tel (Return Materials Authorization)
877-371-2876 Fax (Return Materials Authorization)
return.materials@hypertherm.com (RMA email)

Hypertherm Automation

5 Technology Drive, Suite 300
West Lebanon, NH 03784 USA
603-298-7970 Tel
603-298-7977 Fax

Hypertherm Plasmatechnik GmbH

Technologiepark Hanau
Rodenbacher Chaussee 6
D-63457 Hanau-Wolfgang, Deutschland
49 6181 58 2100 Tel
49 6181 58 2134 Fax
49 6181 58 2123 (Technical Service)

Hypertherm (S) Pte Ltd.

82 Genting Lane
Media Centre
Annexe Block #A01-01
Singapore 349567, Republic of Singapore
65 6841 2489 Tel
65 6841 2490 Fax
65 6841 2489 (Technical Service)

Hypertherm (Shanghai) Trading Co., Ltd.

Unit A, 5th Floor, Careri Building
432 West Huai Hai Road
Shanghai, 200052
PR China
86-21 5258 3330/1 Tel
86-21 5258 3332 Fax

Hypertherm Europe B.V.

Vaartveld 9
4704 SE
Roosendaal, Nederland
31 165 596907 Tel
31 165 596901 Fax
31 165 596908 Tel (Marketing)
31 165 596900 Tel (Technical Service)
00 800 4973 7843 Tel (Technical Service)

Hypertherm Japan Ltd.

Level 9, Edobori Center Building
2-1-1 Edobori, Nishi-ku
Osaka 550-0002 Japan
81 6 6225 1183 Tel
81 6 6225 1184 Fax

Hypertherm Brasil Ltda.

Rua Bras Cubas, 231 – Jardim Maia
Guarulhos, SP - Brasil
CEP 07115-030
55 11 2409 2636 Tel
55 11 2408 0462 Fax

Hypertherm México, S.A. de C.V.

Avenida Toluca No. 444, Anexo 1,
Colonia Olivar de los Padres
Delegación Álvaro Obregón
México, D.F. C.P. 01780
52 55 5681 8109 Tel
52 55 5683 2127 Fax

Hypertherm Korea Branch

#3904 Centum Leaders Mark B/D,
1514 Woo-dong, Haeundae-gu, Busan
Korea, 612-889
82 51 747 0358 Tel
82 51 701 0358 Fax

ELECTROMAGNETIC COMPATIBILITY (EMC)

Introduction

Hypertherm's CE-marked equipment is built in compliance with standard EN60974-10. The equipment should be installed and used in accordance with the information below to achieve electromagnetic compatibility.

The limits required by EN60974-10 may not be adequate to completely eliminate interference when the affected equipment is in close proximity or has a high degree of sensitivity. In such cases it may be necessary to use other measures to further reduce interference.

This cutting equipment is designed for use only in an industrial environment.

Installation and use

The user is responsible for installing and using the plasma equipment according to the manufacturer's instructions.

If electromagnetic disturbances are detected then it shall be the responsibility of the user to resolve the situation with the technical assistance of the manufacturer. In some cases this remedial action may be as simple as earthing the cutting circuit, see *Earthing of the work piece*. In other cases, it could involve constructing an electromagnetic screen enclosing the power source and the work complete with associated input filters. In all cases, electromagnetic disturbances must be reduced to the point where they are no longer troublesome.

Assessment of area

Before installing the equipment, the user shall make an assessment of potential electromagnetic problems in the surrounding area. The following shall be taken into account:

- a. Other supply cables, control cables, signaling and telephone cables; above, below and adjacent to the cutting equipment.
- b. Radio and television transmitters and receivers.
- c. Computer and other control equipment.
- d. Safety critical equipment, for example guarding of industrial equipment.
- e. Health of the people around, for example the use of pacemakers and hearing aids.
- f. Equipment used for calibration or measurement.
- g. Immunity of other equipment in the environment. User shall ensure that other equipment being used in the environment is compatible. This may require additional protection measures.
- h. Time of day that cutting or other activities are to be carried out.

The size of the surrounding area to be considered will depend on the structure of the building and other activities that are taking place. The surrounding area may extend beyond the boundaries of the premises.

Methods of reducing emissions

Mains supply

Cutting equipment must be connected to the mains supply according to the manufacturer's recommendations. If interference occurs, it may be necessary to take additional precautions such as filtering of the mains supply.

Consideration should be given to shielding the supply cable of permanently installed cutting equipment, in metallic conduit or equivalent. Shielding should be electrically continuous throughout its length. The shielding should be connected to the cutting mains supply so that good electrical contact is maintained between the conduit and the cutting power source enclosure.

Maintenance of cutting equipment

The cutting equipment must be routinely maintained according to the manufacturer's recommendations. All access and service doors and covers should be closed and properly fastened when the cutting equipment is in operation. The cutting equipment should not be modified in any way, except as set forth in and in accordance with the manufacturer's written instructions. For example, the spark gaps of arc striking and stabilizing devices should be adjusted and maintained according to the manufacturer's recommendations.

Cutting cables

The cutting cables should be kept as short as possible and should be positioned close together, running at or close to the floor level.

Equipotential bonding

Bonding of all metallic components in the cutting installation and adjacent to it should be considered.

However, metallic components bonded to the workpiece will increase the risk that the operator could receive a shock by touching these metallic components and the electrode (nozzle for laser heads) at the same time.

The operator should be insulated from all such bonded metallic components.

Earthing of the workpiece

Where the workpiece is not bonded to earth for electrical safety, nor connected to earth because of its size and position, for example, ship's hull or building steel work, a connection bonding the workpiece to earth may reduce emissions in some, but not all instances. Care should be taken to prevent the earthing of the workpiece increasing the risk of injury to users, or damage to other electrical equipment. Where necessary, the connection of the workpiece to earth should be made by a direct connection to the workpiece, but in some countries where direct connection is not permitted, the bonding should be achieved by suitable capacitances selected according to national regulations.

Note: The cutting circuit may or may not be earthed for safety reasons. Changing the earthing arrangements should only be authorized by a person who is competent to assess whether the changes will increase the risk of injury, for example, by allowing parallel cutting current return paths which may damage the earth circuits of other equipment. Further guidance is provided in IEC 60974-9, Arc Welding Equipment, Part 9: Installation and Use.

Screening and shielding

Selective screening and shielding of other cables and equipment in the surrounding area may alleviate problems of interference. Screening of the entire plasma cutting installation may be considered for special applications.

Attention

Genuine Hypertherm parts are the factory-recommended replacement parts for your Hypertherm system. Any damage or injury caused by the use of other than genuine Hypertherm parts may not be covered by the Hypertherm warranty, and will constitute misuse of the Hypertherm Product.

You are solely responsible for the safe use of the Product. Hypertherm does not and cannot make any guarantee or warranty regarding the safe use of the product in your environment.

General

Hypertherm, Inc. warrants that its Products shall be free from defects in materials and workmanship for the specific periods of time set forth herein and as follows: if Hypertherm is notified of a defect (i) with respect to the power supply within a period of two (2) years from the date of its delivery to you, with the exception of Powermax brand power supplies, which shall be within a period of three (3) years from the date of delivery to you, and (ii) with respect to the torch and leads within a period of one (1) year from its date of delivery to you, and with respect to torch lifter assemblies within a period of one (1) year from its date of delivery to you, and with respect to laser heads within a period of one (1) year from its date of delivery to you, and with respect to Automation products one (1) year from its date of delivery to you, with the exception of the EDGE Pro and MicroEDGE Pro CNCs and ArcGlide THC, which shall be within a period of two (2) years from the date of delivery to you.

This warranty shall not apply to any Powermax brand power supplies that have been used with phase converters. In addition, Hypertherm does not warranty systems that have been damaged as a result of poor power quality, whether from phase converters or incoming line power. This warranty shall not apply to any Product which has been incorrectly installed, modified, or otherwise damaged.

Hypertherm provides repair, replacement or adjustment of the Product as the sole and exclusive remedy, if and only if the warranty set forth herein properly is invoked and applies. Hypertherm, at its sole option, shall repair, replace, or adjust, free of charge, any defective Products covered by this warranty which shall be returned with Hypertherm's prior authorization (which shall not be unreasonably withheld), properly packed, to Hypertherm's place of business in Hanover, New Hampshire, or to an authorized Hypertherm repair facility, all costs, insurance and freight pre paid by the customer. Hypertherm shall not be liable for any repairs, replacement, or adjustments of Products covered by this warranty, except those made pursuant to this paragraph and with Hypertherm's prior written consent.

The warranty set forth above is exclusive and is in lieu of all other warranties, express, implied, statutory, or otherwise with respect to the Products or as to the results which may be obtained therefrom, and all implied warranties or conditions of quality or of merchantability or fitness for a particular purpose or against infringement. The foregoing shall constitute the sole and exclusive remedy for any breach by Hypertherm of its warranty.

Distributors/OEMs may offer different or additional warranties, but Distributors/OEMs are not authorized to give any additional warranty protection to you or make any representation to you purporting to be binding upon Hypertherm.

Patent indemnity

Except only in cases of products not manufactured by Hypertherm or manufactured by a person other than Hypertherm not in strict conformity with Hypertherm's specifications and in cases of designs, processes, formulae, or combinations not developed or purported to be developed by Hypertherm, Hypertherm will have the right to defend or settle, at its own expense, any suit or proceeding brought against you alleging that the use of the Hypertherm product, alone and not in combination with any other product not supplied by Hypertherm, infringes any patent of any third party. You shall notify Hypertherm promptly upon learning of any action or threatened action in connection with any such alleged infringement (and in any event no longer than fourteen (14) days after learning of any action or threat of action), and Hypertherm's obligation to defend shall be conditioned upon Hypertherm's sole control of, and the indemnified party's cooperation and assistance in, the defense of the claim.

Limitation of liability

In no event shall Hypertherm be liable to any person or entity for any incidental, consequential direct, indirect, punitive or exemplary damages (including but not limited to lost profits) regardless of whether such liability is based on breach of contract, tort, strict liability, breach of warranty, failure of essential purpose, or otherwise, and even if advised of the possibility of such damages.

National and local codes

National and local codes governing plumbing and electrical installation shall take precedence over any instructions contained in this manual. In no event shall Hypertherm be liable for injury to persons or property damage by reason of any code violation or poor work practices.

Liability cap

In no event shall Hypertherm's liability, if any, whether such liability is based on breach of contract, tort, strict liability, breach of warranties, failure of essential purpose or otherwise, for any claim, action, suit or proceeding (whether in court, arbitration, regulatory proceeding or otherwise) arising out of or relating to the use of the Products exceed in the aggregate the amount paid for the Products that gave rise to such claim.

Insurance

At all times you will have and maintain insurance in such quantities and types, and with coverage sufficient and appropriate to defend and to hold Hypertherm harmless in the event of any cause of action arising from the use of the products.

Transfer of rights

You may transfer any remaining rights you may have hereunder only in connection with the sale of all or substantially all of your assets or capital stock to a successor in interest who agrees to be bound by all of the terms and conditions of this Warranty. Within thirty (30) days before any such transfer occurs, you agree to notify in writing Hypertherm, which reserves the right of approval. Should you fail timely to notify Hypertherm and seek its approval as set forth herein, the Warranty set forth herein shall be null and void and you will have no further recourse against Hypertherm under the Warranty or otherwise.

Safety information

Before operating any Hypertherm equipment, read the separate *Safety and Compliance Manual* (80669C) included with your product for important safety information.

Section 1

Specifications

Safety information 1-2

System description 1-2

Where to find information 1-3

Power supply dimensions 1-4

Component weights (105 A systems) 1-5

Powermax105 power supply ratings 1-6

Duramax 75° hand torch dimensions 1-8

Duramax 15° hand torch dimensions 1-8

Duramax 180° full-length machine torch dimensions 1-9

Duramax 180° mini machine torch dimensions 1-9

Powermax105 cutting specifications 1-10

Symbols and markings 1-11

Noise levels 1-11

IEC symbols 1-12

Section 2

Power Supply Setup

Unpack the Powermax system 2-2

 Claims 2-2

 Contents 2-3

Position the power supply 2-4

Prepare the electrical power 2-4

 Install a line-disconnect switch 2-5

 Requirements for grounding 2-5

Power connection for the Powermax105 2-6

 Three-phase power cord and plug installation 2-8

Extension cord recommendations 2-9

 Extension cord specifications 2-9

 Engine-driven generator recommendations 2-10

Prepare the gas supply 2-11

 Additional gas filtration 2-11

 Connect the gas supply 2-12

TABLE OF CONTENTS

Section 3

Basic System Operations

Controls and indicators	3-2
Rear controls	3-2
Front controls and LEDs	3-2
Status screen	3-4
Operating the Powermax105	3-6
Connect the electrical power, gas supply, and torch lead	3-6
Attach the work lead to the power supply	3-7
Attach the work clamp to the workpiece	3-8
Turn ON the system	3-9
Set the operating mode switch	3-9
Check the indicators	3-10
Manually adjusting the gas pressure	3-10
Adjusting the current (amperage)	3-11
Electrode end-of-life detection feature	3-11
Understanding duty-cycle limitations	3-12

Section 4

Hand Torch Setup

Introduction	4-2
Consumable life	4-2
Hand torch components	4-3
Choose the hand torch consumables	4-4
Drag-cutting 105 A consumables	4-4
Drag-cutting 45 A, 65 A, 85 A consumables	4-4
Hand torch consumables	4-5
Gouging consumables	4-5
FineCut® consumables	4-5
Install the hand torch consumables	4-6
Connecting the torch lead	4-7

Section 5

Hand Cutting

Using the hand torch	5-2
Operate the safety trigger	5-2
Hand torch cutting hints	5-3
Start a cut from the edge of the workpiece	5-4
Pierce a workpiece	5-5
Gouge a workpiece	5-6
Gouge profile	5-7
Varying the gouge profile	5-8
Common hand-cutting faults	5-8

Section 6

Machine Torch Setup

Introduction 6-3

Consumable life..... 6-3

Machine torch components..... 6-4

Converting a full-length machine torch to a mini machine torch 6-5

Mount the torch 6-7

Choose the machine torch consumables..... 6-9

Machine torch consumables 6-9

 Mechanized shielded 105 A consumables 6-9

 Mechanized shielded 45 A, 65 A, 85 A consumables 6-9

 Mechanized shielded with ohmic 105 A consumables 6-10

 Mechanized shielded with ohmic 45 A, 65 A, 85 A consumables 6-10

 Mechanized unshielded 105 A consumables..... 6-10

 Mechanized unshielded 45 A, 65 A, 85 A consumables..... 6-10

 Gouging consumables..... 6-11

 FineCut® shielded consumables..... 6-11

 FineCut® unshielded consumables 6-11

Install the machine torch consumables..... 6-12

Aligning the torch..... 6-12

Connecting the torch lead..... 6-13

Using the cut charts 6-14

 Estimated kerf-width compensation..... 6-15

 105 A Shielded consumables..... 6-17

 105 A Shielded cutting (Mild Steel) 6-18

 105 A Shielded cutting (Stainless Steel)..... 6-19

 105 A Shielded cutting (Aluminum)..... 6-20

 85 A Shielded consumables..... 6-21

 85 A Shielded cutting (Mild Steel)..... 6-22

 85 A Shielded cutting (Stainless Steel)..... 6-23

 85 A Shielded cutting (Aluminum) 6-24

 65 A Shielded consumables..... 6-25

 65 A Shielded cutting (Mild Steel)..... 6-26

 65 A Shielded cutting (Stainless Steel)..... 6-27

 65 A Shielded cutting (Aluminum) 6-28

 45 A Shielded consumables..... 6-29

 45 A Shielded cutting (Mild Steel)..... 6-30

 45 A Shielded cutting (Stainless Steel)..... 6-31

 45 A Shielded cutting (Aluminum) 6-32

TABLE OF CONTENTS

FineCut® consumables.....	6-33
FineCut (Mild Steel).....	6-34
FineCut (Stainless Steel).....	6-35
Low Speed FineCut (Mild Steel).....	6-36
Low Speed FineCut (Stainless Steel).....	6-37
105 A Unshielded consumables.....	6-38
105 A Unshielded cutting (Mild Steel).....	6-39
105 A Unshielded cutting (Stainless Steel).....	6-40
105 A Unshielded cutting (Aluminum).....	6-41
85 A Unshielded consumables.....	6-42
85 A Unshielded cutting (Mild Steel).....	6-43
85 A Unshielded cutting (Stainless Steel).....	6-44
85 A Unshielded cutting (Aluminum).....	6-45
65 A Unshielded consumables.....	6-46
65 A Unshielded cutting (Mild Steel).....	6-47
65 A Unshielded cutting (Stainless Steel).....	6-48
65 A Unshielded cutting (Aluminum).....	6-49
45 A Unshielded consumables.....	6-50
45 A Unshielded cutting (Mild Steel).....	6-51
45 A Unshielded cutting (Stainless Steel).....	6-52
45 A Unshielded cutting (Aluminum).....	6-53

Section 7

Mechanized Cutting

Connecting an optional remote-start pendant.....	7-2
Connecting an optional machine interface cable.....	7-3
Machine interface pinout.....	7-5
Setting the five-position voltage divider.....	7-6
Connecting an optional RS485 serial interface cable.....	7-7
Using the machine torch.....	7-8
Setting up the torch and table.....	7-8
Understand and optimize cut quality.....	7-8
Cut or bevel angle.....	7-8
Dross.....	7-9
Piercing a workpiece using the machine torch.....	7-10
Common machine-cutting faults.....	7-11

Section 8**Maintenance and Repair**

Perform routine maintenance	8-2
Inspect the consumables	8-3
Basic troubleshooting	8-4
Fault codes and solutions	8-6
Replace the gas filter element	8-9

Section 9**Parts**

Power supply parts.....	9-2
Duramax 75° hand torch replacement parts.....	9-6
Duramax 15° hand torch replacement parts.....	9-7
Hand torch consumables.....	9-8
Duramax 180° full-length machine torch replacement parts	9-9
Duramax 180° mini machine torch replacement parts	9-11
Machine torch consumables	9-13
Accessory parts.....	9-14
Powermax105 labels.....	9-15

Section 1

SPECIFICATIONS

In this section:

Safety information 1-2

System description..... 1-2

Where to find information 1-3

Power supply dimensions 1-4

Component weights (105 A systems)..... 1-5

Powermax105 power supply ratings..... 1-6

Duramax 75° hand torch dimensions 1-8

Duramax 15° hand torch dimensions 1-8

Duramax 180° full-length machine torch dimensions..... 1-9

Duramax 180° mini machine torch dimensions..... 1-9

Powermax105 cutting specifications 1-10

Symbols and markings..... 1-11

Noise levels 1-11

IEC symbols 1-12

Safety information

Before you set up and operate your Hypertherm system, read the separate *Safety and Compliance Manual* included with your system for important safety information.

System description

The Powermax105 is a highly portable, 105-amp, handheld and mechanized plasma cutting system appropriate for a wide range of applications. The Powermax system uses air or nitrogen to cut electrically conductive metals, such as mild steel, stainless steel, or aluminum. Smart Sense™ technology automatically adjusts the gas pressure according to cutting mode and torch lead length for optimum cutting.

The Powermax105 can cut thicknesses up to 38 mm (1-1/2 inches) and pierce thicknesses up to 22 mm (7/8 inch). FastConnect™ provides a simple push-button torch connection to the power supply for quick torch changes.

The typical handheld Powermax system includes a Duramax™ series 75° hand torch with a consumables box and work lead cable. Reference materials include: operator manual, quick setup card, registration card, setup DVD, and safety manual.

The typical mechanized Powermax system includes a Duramax series 180° full-length machine torch with a consumables box, work lead cable, and remote-start pendant. Reference materials include: operator manual, quick setup card, registration card, setup DVD, and safety manual.

See your Hypertherm distributor for other system configurations. You can order additional styles of torches, consumables, and accessories such as the plasma cutting guide. See the *Parts* section for a list of spare and optional parts.

Powermax105 power supplies are shipped without a plug on the power cord. See the *Power Supply Setup* section for more information.

Note: Some CCC certified configurations do not ship with a power cord.

Powermax105 3-phase systems include the following models:

- The 200–600 V CSA model is a universal power supply that can automatically adjust to operate with AC voltages from 200 to 600 V.
- The 230-400 V CE model can automatically adjust from 230 to 400 V.
- The 380 V CCC/230–400 V CE model can automatically adjust from 230 to 400 V.

Note: To maintain CE certification, install power cord kit 228886.

- The 400 V CE model is 400 V only.
- The 380 V CCC model is 380 V only.

Where to find information

System specifications such as size, weight, detailed electrical specifications, and cut speeds can be found in this section. For information on:

- Setup requirements, including power requirements, grounding, power cord configurations, extension cord requirements, and generator recommendations — See the *Power Supply Setup* section.
- Handheld and machine torch consumables, cut charts, and torch setup information — See the *Hand Torch Setup* or *Machine Torch Setup* section.
- Information about the controls and LEDs, steps for system operation, and hints for improving cut quality — See the *Basic System Operations*, *Hand Cutting*, and *Mechanized Cutting* sections.

The manual also contains sections on troubleshooting and ordering parts for your system.

SPECIFICATIONS

Power supply dimensions

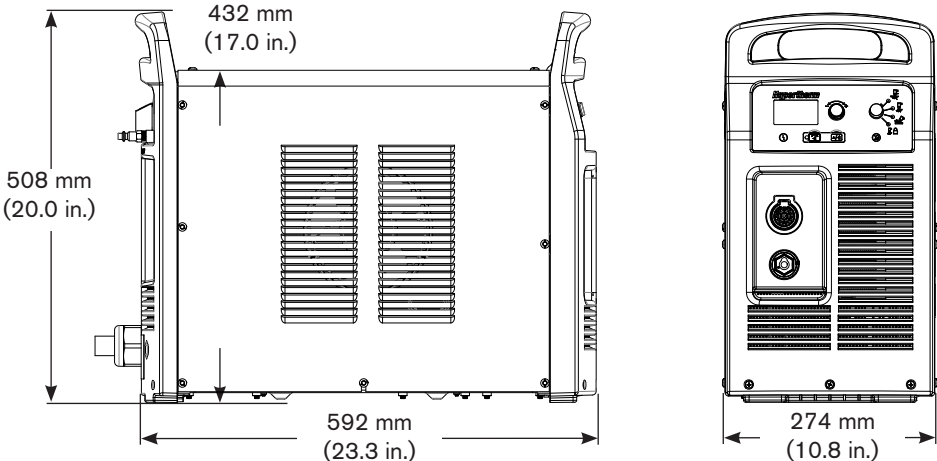

Component weights (105 A systems)

	200–600 V CSA	230–400 V CE	400 V CE	380 V CCC	380 V CCC/ 230–400 V CE
Power supply	40 kg (88 lbs)	39 kg (87 lbs)	35 kg (78 lbs)	With power cord 35 kg (78 lbs) No power cord 34 kg (74 lbs)	No power cord 36 kg (79 lbs)
With 7.6 m (25 ft) hand torch and 7.6 m (25 ft) work lead	45 kg (100 lbs)	45 kg (100 lbs)	41 kg (91 lbs)	With power cord 41 kg (91 lbs) No power cord 39 kg (87 lbs)	No power cord 42 kg (92 lbs)

Hand torch 7.6 m (25 ft)	3.3 kg (7.3 lbs)
Hand torch 15 m (50 ft)	5.9 kg (13.0 lbs)
Hand torch 23 m (75 ft)	8.4 kg (18.5 lbs)

Machine torch 4.6 m (15 ft)	2.4 kg (5.4 lbs)
Machine torch 7.6 m (25 ft)	3.4 kg (7.6 lbs)
Machine torch 11 m (35 ft)	4.5 kg (10.0 lbs)
Machine torch 15 m (50 ft)	6.2 kg (13.7 lbs)
Machine torch 23 m (75 ft)	8.7 kg (19.3 lbs)

Work lead 7.6 m (25 ft)	2.4 kg (5.3 lbs)
Work lead 15 m (50 ft)	4.4 kg (9.6 lbs)
Work lead 23 m (75 ft)	6.1 kg (13.4 lbs)

SPECIFICATIONS

Powermax105 power supply ratings

Rated open-circuit voltage (U_0)	200–600 V CSA 230–400 V CE 380 V CCC/230–400 V CE 400 V CE 380 V CCC	300 VDC 288 VDC 288 VDC 292 VDC 280 VDC
Output characteristic ¹	Drooping	
Rated output current (I_2)	30–105 A	
Rated output voltage (U_2)	160 VDC	
Duty cycle at 40° C (104° F)	200–600 V CSA 230–400 V CE or 380 V CCC/230–400 V CE 400 V CE 380 V CCC	80% @ 105 A, 480–600 V, 3-PH 70% @ 105 A 240 V, 3-PH 54% @ 105 A 208 V, 3-PH 50% @ 105 A, 200 V, 3-PH 100% @ 94 A, 480–600 V, 3-PH 100% @ 88 A, 240 V, 3-PH 100% @ 77 A, 208 V, 3-PH 100% @ 74 A, 200 V, 3-PH 80% @ 105 A, 400 V, 3-PH 70% @ 105 A, 230 V, 3-PH 100% @ 94 A, 400 V, 3-PH 100% @ 88 A, 230 V, 3-PH 80% @ 105 A, 400 V, 3-PH 100% @ 94 A, 400 V, 3-PH 80% @ 105 A, 380 V, 3-PH 100% @ 94 A, 380 V, 3-PH
Operating temperature	-10° to 40° C (14° to 104° F)	
Storage temperature	-25° to 55° C (-13° to 131° F)	
Power factor 200–600 V CSA, 3-PH 230–400 V CE, 3-PH 380 V CCC/230–400 V CE, 3-PH 400 V CE, 3-PH 380 V CCC, 3-PH	0.94–0.77 0.94–0.92 0.94–0.92 0.94 0.94	
R_{sce} – Short Circuit Ratio (CE models only)	U_1 – Volts AC rms, 3-PH	R_{sce}
	230-400 V CE 400 V CE	275 230

EMC classification CISPR 11 (CE models only) ⁴		Class A
Input voltage (U_1)/ Input current (I_1) at rated output ($U_{2\text{ MAX}}$, $I_{2\text{ MAX}}$) (See the <i>Power Supply Setup</i> section for more information.)	200–600 V CSA	200/208/240/480/600 V, 3-PH, 50/60 Hz 58/56/49/25/22 A
	380 V CCC/ 230–400 V CE ^{2,3}	230–400 V, 3-PH, 50/60 Hz 50/29 A
	230–400 V CE ^{2,3}	230–400 V, 3-PH, 50/60 Hz 50/29 A
	400 V CE ^{3,5}	400 V, 3-PH, 50/60 Hz 28 A
	380 V CCC	380 V, 3-PH, 50/60 Hz 30 A
Gas type	Air	Nitrogen
Gas quality	Clean, dry, oil-free per ISO 8573-1 Class 1.2.2	99.95% pure
Recommended gas inlet flow rate/ pressure	Cutting: 220 slpm (460 scfh , 7.7 scfm) @ 5.9 bar (85 psi) Gouging: 230 slpm (480 scfh, 8.0 scfm) @ 4.8 bar (70 psi)	

¹ Defined as a plot of output voltage versus output current.

² Equipment complies with IEC 61000-3-12 provided that the short-circuit power S_{sc} is greater than or equal to 5528 KVA at the interface point between the user's supply and the public system. It is the responsibility of the installer or user of the equipment to ensure, by consultation with the distribution network operator if necessary, that the equipment is connected only to a supply with a short-circuit power S_{sc} greater than or equal to 5528 KVA.

³ This product meets the technical requirements of IEC 61000-3-3 and is not subject to conditional connection.

⁴ **WARNING:** This Class A equipment is not intended for use in residential locations where the electrical power is provided by the public low-voltage supply system. There may be potential difficulties in ensuring electromagnetic compatibility in those locations, due to conducted as well as radiated disturbances.

⁵ Equipment complies with IEC 61000-3-12 provided that the short-circuit power S_{sc} is greater than or equal to 4462 KVA at the interface point between the user's supply and the public system. It is the responsibility of the installer or user of the equipment to ensure, by consultation with the distribution network operator if necessary, that the equipment is connected only to a supply with a short-circuit power S_{sc} greater than or equal to 4462 KVA.

SPECIFICATIONS

Duramax 75° hand torch dimensions

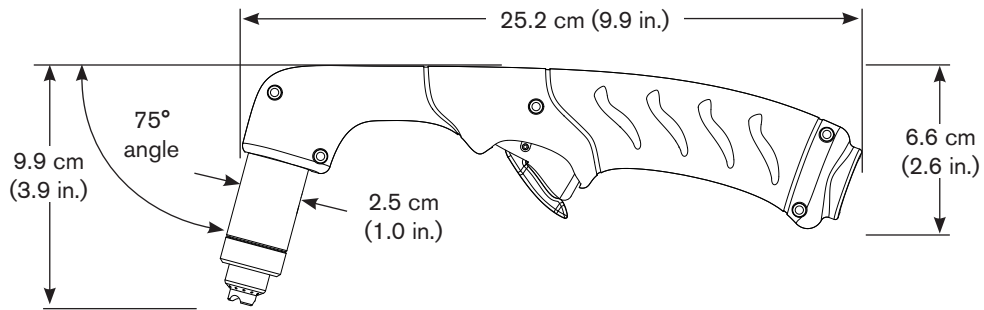

Duramax 15° hand torch dimensions

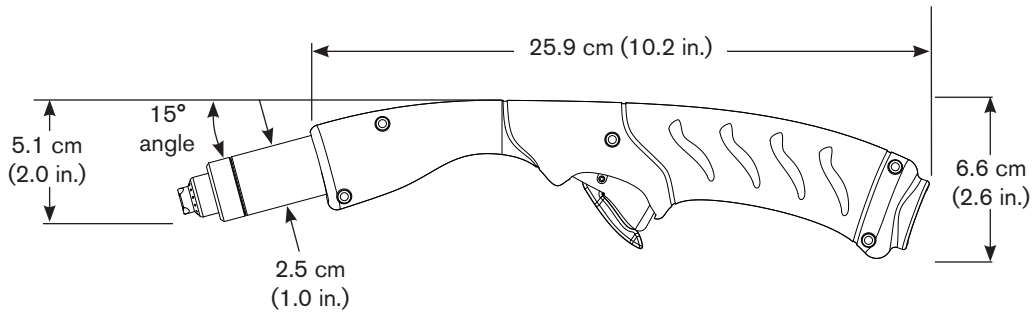

Duramax 180° full-length machine torch dimensions

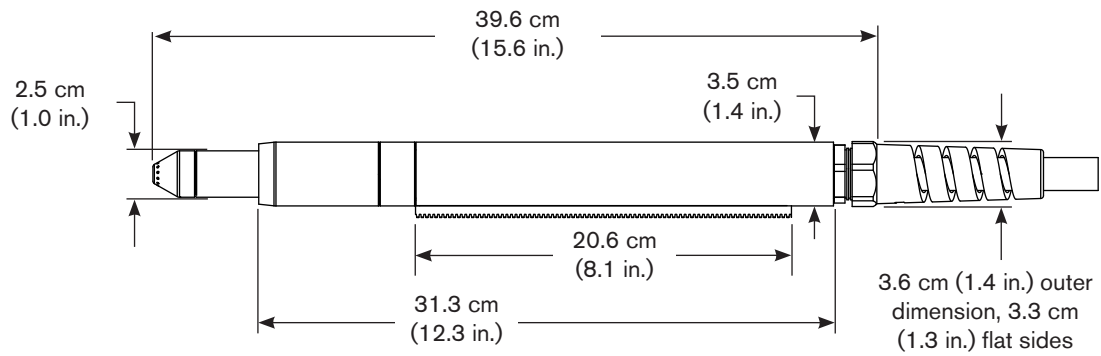

Duramax 180° mini machine torch dimensions

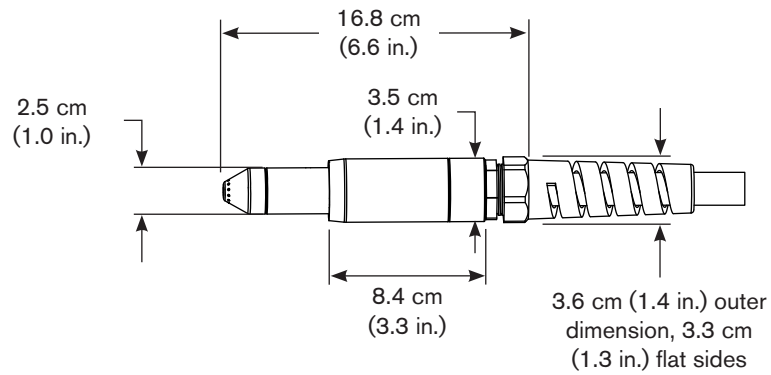

SPECIFICATIONS

Powermax105 cutting specifications

Handheld cut capacity (material thickness)	
Recommended cut capacity at 500 mm/min (20 ipm)*	32 mm (1-1/4 in.)
Recommended cut capacity at 250 mm/min (10 ipm)*	38 mm (1-1/2 in.)
Severance capacity at 125 mm/min (5 ipm)*	50 mm (2 in.)
Pierce capacity (material thickness)	
Pierce capacity for handheld cutting, or mechanized cutting with programmable torch height control	22 mm (7/8 in.)
Pierce capacity for mechanized cutting without programmable torch height control	20 mm (3/4 in.)
Maximum cut speed** (mild steel)	
6 mm (1/4 in.)	5600 mm/min (220 ipm)
12 mm (1/2 in.)	2400 mm/min (95 ipm)
20 mm (3/4 in.)	1300 mm/min (50 ipm)
25 mm (1 in.)	760 mm/min (30 ipm)
32 mm (1-1/4 in.)	510 mm/min (20 ipm)
Gouging capacity	
Metal removal rate on mild steel (65 A)	4.8 kg/hr (10.7 lbs/hr)
Metal removal rate on mild steel (85 A)	8.8 kg/hr (19.5 lbs/hr)
Metal removal rate on mild steel (105 A)	9.8 kg/hr (21.7 lbs/hr)
Duramax series torch weights (refer to page 1-5 <i>Component weights (105 A systems)</i>)	
Duty cycle and voltage information (refer to page 1-6 <i>Powermax105 power supply ratings</i>)	

* Cut capacity speeds are not necessarily maximum speeds. They are the speeds that must be achieved to be rated at that thickness.

** Maximum cut speeds are the results of Hypertherm's laboratory testing. Actual cutting speeds may vary based on different cutting applications.

Symbols and markings

Your Hypertherm product may have one or more of the following markings on or near the data plate. Due to differences and conflicts in national regulations, not all marks are applied to every version of a product.



S mark symbol

The S mark symbol indicates that the power supply and torch are suitable for operations carried out in environments with increased hazard of electrical shock per IEC 60974-1.



CSA mark

Hypertherm products with a CSA mark meet the United States and Canadian regulations for product safety. The products were evaluated, tested, and certified by CSA-International. Alternatively the product may have a mark by one of the other Nationally Recognized Testing Laboratories (NRTL) accredited in both the United States and Canada, such as Underwriters Laboratories, Incorporated (UL) or TÜV.



CE marking

The CE marking signifies the manufacturer's declaration of conformity to applicable European directives and standards. Only those versions of Hypertherm products with a CE marking located on or near the data plate have been tested for compliance with the European Low Voltage Directive and the European Electromagnetic Compatibility (EMC) Directive. EMC filters needed to comply with the European EMC Directive are incorporated within versions of the product with a CE marking.



GOST-R mark

CE versions of Hypertherm products that include a GOST-R mark of conformity meet the product safety and EMC requirements for export to the Russian Federation.



c-Tick mark

CE versions of Hypertherm products with a c-Tick mark comply with the EMC regulations required for sale in Australia and New Zealand.



CCC mark

The China Compulsory Certification (CCC) mark indicates that the product has been tested and found compliant with product safety regulations required for sale in China.



UkrSEPRO mark

CE versions of Hypertherm products that include a UkrSEPRO mark of conformity meet the product safety and EMC requirements for export to the Ukraine.

Noise levels

Acceptable noise levels as defined by national and local codes may be exceeded by this plasma system. Always wear proper ear protection when cutting or gouging. Any noise measurements taken are dependant on the specific environment in which the system is used. See also *Noise can damage hearing* in the *Safety and Compliance Manual* included with your system. Specific information by product can be found in the Hypertherm downloads library at:



















<https://www.hypertherm.com/>

Click Downloads library, select a product from the Product Type drop-down menu, select "Regulatory" from the Category drop-down menu, and select "Acoustical Noise Data Sheets" from the Sub Category drop-down menu.

SPECIFICATIONS

IEC symbols

The following symbols may appear on the power supply data plate, control labels, switches, LEDs, and LCD screen.

	Direct current (DC)		Power is ON
	Alternating current (AC)		Power is OFF
	Plasma torch cutting		An inverter-based power source, either 1-phase or 3-phase
	Plate metal cutting		
	Expanded metal cutting		Volt/amp curve, "drooping" characteristic
	Gouging		Power is ON (LED)
	AC input power connection		System fault (LED)
	The terminal for the external protective (earth) conductor		Inlet gas pressure fault (LCD)
			Missing or loose consumables (LCD)
			Power supply is out of temperature range (LCD)

Section 2

POWER SUPPLY SETUP

In this section:

Unpack the Powermax system.....	2-2
Claims	2-2
Contents.....	2-3
Position the power supply.....	2-4
Prepare the electrical power	2-4
Install a line-disconnect switch	2-5
Requirements for grounding	2-5
Power connection for the Powermax105.....	2-6
Three-phase power cord and plug installation	2-8
Extension cord recommendations.....	2-9
Extension cord specifications.....	2-9
Engine-driven generator recommendations	2-10
Prepare the gas supply.....	2-11
Additional gas filtration.....	2-11
Connect the gas supply.....	2-12

Unpack the Powermax system

1. Verify that all items on your order have been received in good condition. Contact your distributor if any parts are damaged or missing.
2. Inspect the power supply for damage that may have occurred during shipping. If there is evidence of damage, refer to *Claims* below. All communications regarding this equipment must include the model number and the serial number located on the back of the power supply.
3. Before you set up and operate this Hypertherm system, read the separate *Safety and Compliance Manual* included with your system for important safety information.

Claims

- **Claims for damage during shipment** – If your unit was damaged during shipment, you must file a claim with the carrier. Hypertherm will furnish you with a copy of the bill of lading upon request. If you need additional assistance, call the nearest Hypertherm office listed in the front of this manual.
- **Claims for defective or missing merchandise** – If any component is missing or defective, contact your Hypertherm distributor. If you need additional assistance, call the nearest Hypertherm office listed in the front of this manual.

Contents

The following illustration shows typical system components. A vinyl cap is installed on torches that ship with new systems. Consumables are included in the consumables box.

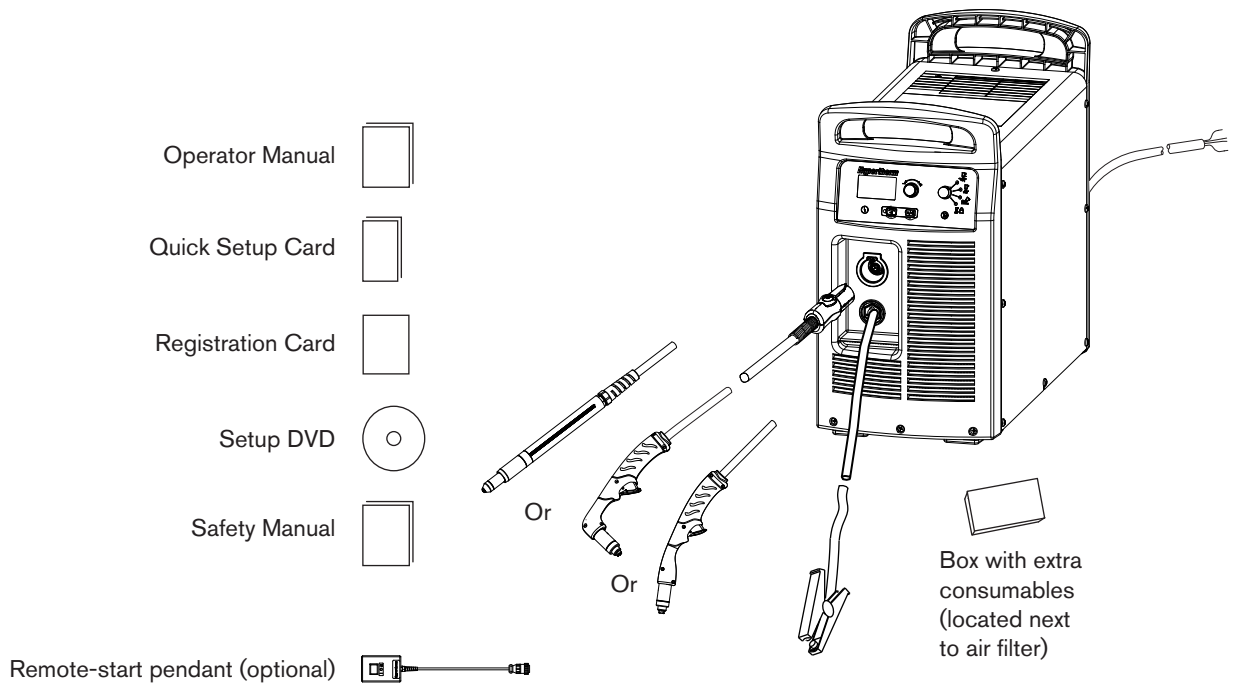

Position the power supply

Locate the power supply near an appropriate power receptacle for your installation:

- 200–600 volts (3-phase, CSA certified)
- 230-400 volts (3-phase, CE certified)
- 380/230–400 volts (3-phase, CCC/CE certified) without power cord

Note: To maintain CE certification, install power cord kit 228886.

- 400 volts (3-phase, CE certified)
- 380 volts (3-phase, CCC certified).

The power supply has a 3 m (10 ft) power cord (depending upon the model). Allow at least 0.25 m (10 inches) of space around the power supply for proper ventilation.

The power supply is not suitable for use in rain or snow.

To avoid toppling, do not set the power supply on an incline greater than 10 degrees.

Prepare the electrical power

Hypertherm (designated HYP on the data plate) input current ratings are used to determine conductor sizes for power connection and installation instructions. The HYP rating is determined under maximum normal operating conditions and the higher HYP input current value should be used for installation purposes.

The maximum output voltage will vary based on your input voltage and the circuit's amperage. Because the current draw varies during startup, slow-blow fuses are recommended as shown in the charts on page 2-6. Slow-blow fuses can withstand currents up to 10 times the rated value for short periods of time.



Caution: Protect the circuit with appropriately sized time-delay (slow-blow) fuses and a line-disconnect switch.

Install a line-disconnect switch

Use a line-disconnect switch for each power supply so that the operator can turn off the incoming power quickly in an emergency. Locate the switch so that it is easily accessible to the operator. Installation must be performed by a licensed electrician according to national and local codes. The interrupt level of the switch must equal or exceed the continuous rating of the fuses. In addition, the switch should:

- Isolate the electrical equipment and disconnect all live conductors from the incoming supply voltage when in the OFF position.
- Have one OFF and one ON position that are clearly marked with O (OFF) and I (ON).
- Have an external operating handle that can be locked in the OFF position.
- Contain a power-operated mechanism that serves as an emergency stop.
- Have appropriate slow-blow fuses installed. See page 2-6 *Power connection for the Powermax105* for recommended fuse sizes.

Requirements for grounding

To ensure personal safety, proper operation, and to reduce electromagnetic interference (EMI), the power supply must be properly grounded.

- The power supply must be grounded through the power cord according to national and local electrical codes.
- Three-phase service must be of the 4-wire type with a green or green/yellow wire for protective earth ground and must comply with national and local requirements.
- Refer to the separate *Safety and Compliance Manual* included with your system for more information on grounding.

Power connection for the Powermax105

Powermax105 3-phase systems include the following models:

- The 200–600 V CSA model is a universal power supply that can automatically adjust to operate with AC voltages from 200 to 600 V.
- The 230-400 V CE model can automatically adjust from 230 to 400 V.
- The 380 V CCC/230–400 V CE model can automatically adjust from 230 to 400 V.

Note: To maintain CE certification, install power cord kit 228886.

- The 400 V CE model is 400 V only.
- The 380 V CCC model is 380 V only.

The rated output is 30–105 A, 160 VDC.

200–600 V CSA,					
Input voltage (V)	200	208	240	480	600
Input current (A) at rated output (16.8 kw)	58	56	49	25	22
Input current (A) at arc stretch	82	82	78	40	35
Fuse, slow-blow (A)	80	80	80	40	40

230–400 V CE		
Input voltage (V)	230	400
Input current (A) at rated output (16.8 kw)	50	29
Input current (A) at arc stretch	80	46
Fuse, slow-blow (A)	80	50

380 V CCC/230–400 V CE			
Input voltage (V)	230	400	380
Input current (A) at rated output (16.8 kw)	50	29	30
Input current (A) at arc stretch	80	46	42
Fuse, slow-blow (A)	80	50	50

400 V CE	
Input voltage (V)	400
Input current (A) at rated output (16.8 kw)	28
Input current (A) at arc stretch	44
Fuse, slow-blow (A)	50

380 V CCC	
Input voltage (V)	380
Input current (A) at rated output (16.8 kw)	30
Input current (A) at arc stretch	42
Fuse, slow-blow (A)	50

POWER SUPPLY SETUP

Three-phase power cord and plug installation

Powermax105 power supplies are shipped with the following power cords:

- CSA models: 6 AWG 4-wire power cord
- 230-400 V CE: 10 mm², 4-wire HAR power cord
- 380 V CCC/230–400 V CE ships without a power cord

Note: To maintain CE certification, install power cord kit 228886.

- 400 V CE: 6 mm², 4-wire HAR power cord
- 380 V CCC: 6 mm², 4-wire CCC power cord (some models ship without a power cord)

To operate the Powermax105, use a plug that meets national and local electrical codes. The plug must be connected to the power cord by a licensed electrician.

Strip and prepare the power cord wires as shown below.

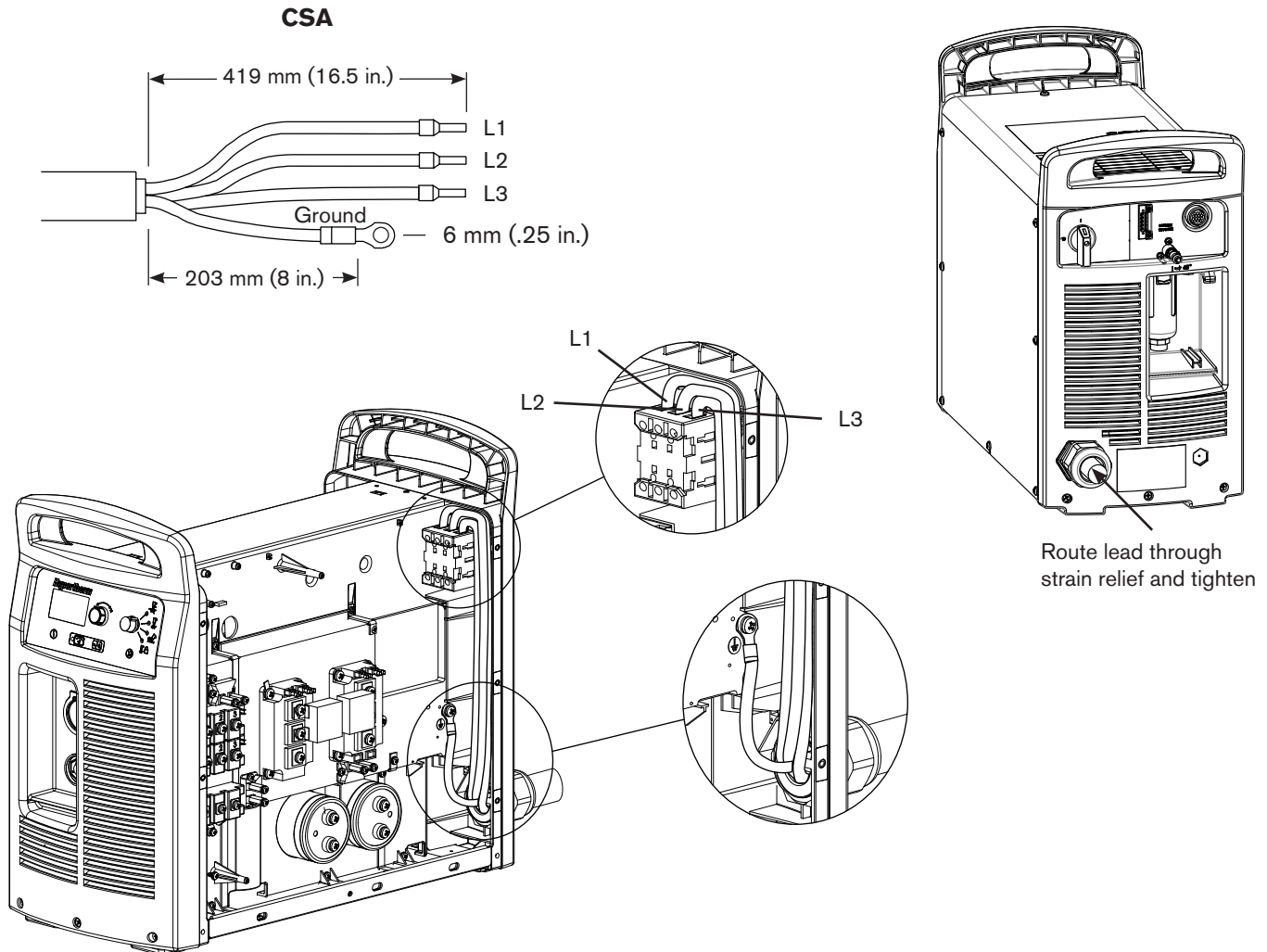

Extension cord recommendations

Any extension cord must have an appropriate wire size for the cord length and system voltage. Use a cord that meets national and local codes.

The table on the next page provides the recommended gauge sizes for various lengths and input voltages. The lengths in the tables are the length of the extension cord only; they do not include the power supply's power cord.

Extension cord specifications

Extension cord length		< 3 m (< 10 ft)	3–7.5 m (10–25 ft)	7.5–15 m (25–50 ft)	15–30 m (50–100 ft)	30–45 m (100–150 ft)
200–600 V CSA						
Input voltage (VAC)	Phase	mm ² (AWG)	mm ² (AWG)	mm ² (AWG)	mm ² (AWG)	mm ² (AWG)
200–240	3	16 (6)	16 (6)	16 (6)	25 (4)	35 (2)
480–600	3	6 (10)	6 (10)	6 (10)	6 (10)	6 (10)
230–400 V CE						
Input voltage (VAC)	Phase	mm ²	mm ²	mm ²	mm ²	mm ²
230	3	16	16	16	25	25
400	3	10	10	10	10	10
380 V CCC/230–400 V CE						
Input voltage (VAC)	Phase	mm ²	mm ²	mm ²	mm ²	mm ²
230	3	16	16	16	25	25
400	3	10	10	10	10	10
380	3	10	10	10	10	10
400 V CE						
Input voltage (VAC)	Phase	mm ²	mm ²	mm ²	mm ²	mm ²
400	3	10	10	10	10	10
380 V CCC						
Input voltage (VAC)	Phase	mm ²	mm ²	mm ²	mm ²	mm ²
380	3	10	10	10	10	10

POWER SUPPLY SETUP

Engine-driven generator recommendations

Generators used with the Powermax105 should satisfy the following requirements:

200–600 V CSA

3-phase, 50/60 Hz, 200–600 VAC (480 VAC recommended for best performance)

230-400 V CE

3-phase, 50/60 Hz, 230-400 VAC (400 VAC recommended for best performance)

380 V CCC/230–400 V CE

3-phase, 50/60 Hz, 230-400 VAC (400 VAC recommended for best performance)

400 V CE

3-phase, 50/60 Hz, 400 VAC (400 VAC recommended for best performance)

380 V CCC

3-phase, 50/60 Hz, 380 VAC (380 VAC recommended for best performance)

Engine drive rating	System output current	Performance (arc stretch)
30 kw	105 A	Full
22.5–25	105 A	Limited
20 kw	85 A	Full
15 kw	70 A	Limited
15 kw	65 A	Full
12 kw	65 A	Limited
12 kw	40 A	Full
8 kw	40 A	Limited
8 kw	30 A	Full

Note: Based on the generator rating, age, and condition, adjust the cutting current as needed.

If a fault occurs while using a generator, turning the power switch quickly to OFF and then to ON again (sometimes called a “quick reset”) may not clear the fault. Instead, turn OFF the power supply and wait 60 to 70 seconds before turning ON again.

Prepare the gas supply

The air can be supplied by a compressor or from high-pressure cylinders. A high-pressure regulator must be used on either type of supply and must be capable of delivering gas to the air inlet on the power supply.

If the supply quality is poor, cut speeds decrease, cut quality deteriorates, cutting thickness capability decreases, and the life of the consumables shortens. For optimal performance, the gas should be compliant with ISO8573-1:2010, Class 1.2.2 (that is, it should have a maximum number of solid particulate per m³ of <20,000 for particle sizes in the range of 0.1-0.5 microns, <400 for particle sizes in the range of 0.5-1 microns, and <10 for particle sizes in the range of 1-5 microns). The maximum water vapor dew point should be <-40° C (-40° F). The maximum oil (aerosol, liquid, and vapor) content should be less than 0.1 mg/m³.

Additional gas filtration

When site conditions introduce moisture, oil, or other contaminants into the gas line, use a 3-stage coalescing filtration system, such as the Eliminer filter kit (part number 228890) available from Hypertherm distributors. A 3-stage filtering system works as shown below to clean contaminants from the gas supply.

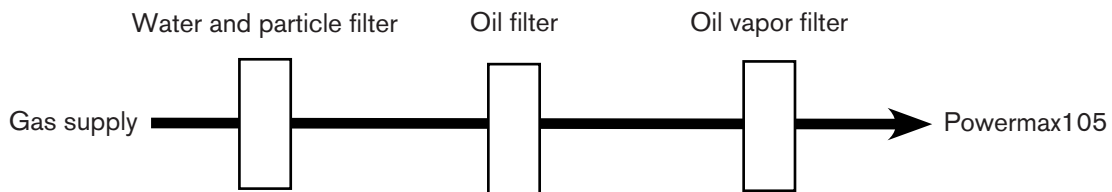

The filtering system should be installed between the gas supply and the power supply. Additional gas filtration may increase the required minimum inlet pressure.

POWER SUPPLY SETUP

Connect the gas supply

Connect the gas supply to the power supply using an inert-gas hose with a 9.5 mm (3/8 inch) internal diameter and a 1/4 NPT quick-disconnect coupler, or a 1/4 NPT x G-1/4 BSPP (CE units) quick-disconnect coupler.

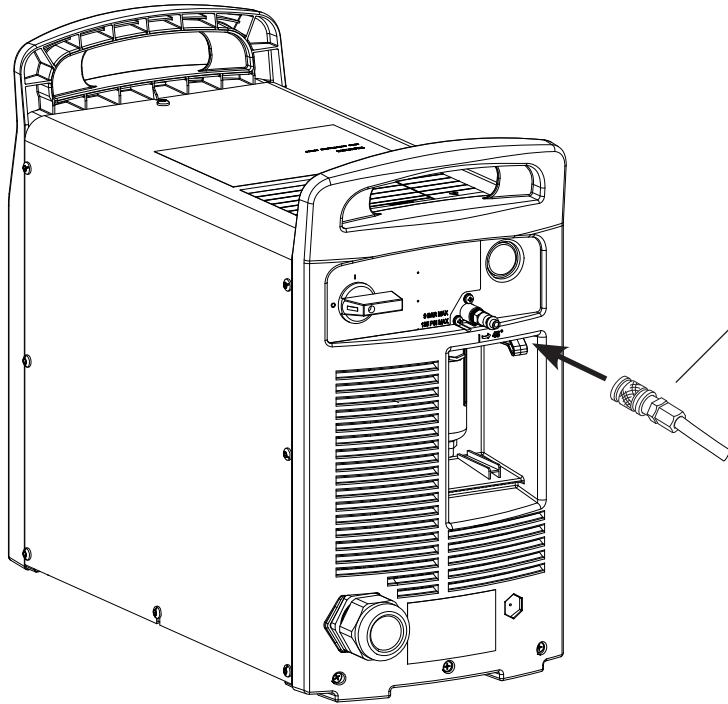

The recommended inlet pressure while gas is flowing is 5.9 - 9.3 bar (85 - 135 psi).



WARNING

Do not allow the gas supply pressure to exceed 9.3 bar (135 psi). The filter bowl may explode if this pressure is exceeded.

Minimum inlet pressure (while gas is flowing)

This table shows the minimum required inlet pressure when the recommended inlet pressure is not available.

	Torch lead length		
	7.6 m (25 ft)	15.2 m (50 ft)	22.9 m (75 ft)
Cutting	5.2 bar (75 psi)	5.5 bar (80 psi)	5.9 bar (85 psi)
Gouging	4.1 bar (60 psi)	4.5 bar (65 psi)	4.8 bar (70 psi)

Gas flow rates

Cutting	220 slpm (460 scfh, 7.7 scfm) at a minimum 5.9 bar (85 psi)
Gouging	230 slpm (480 scfh, 8.0 scfm) at a minimum 4.8 bar (70 psi)

Section 3

BASIC SYSTEM OPERATIONS

In this section:

Controls and indicators	3-2
Rear controls	3-2
Front controls and LEDs	3-2
Status screen	3-4
Operating the Powermax105	3-6
Connect the electrical power, gas supply, and torch lead	3-6
Attach the work lead to the power supply	3-7
Attach the work clamp to the workpiece	3-8
Turn ON the system	3-9
Set the operating mode switch	3-9
Check the indicators	3-10
Manually adjusting the gas pressure	3-10
Adjusting the current (amperage)	3-11
Electrode end-of-life detection feature	3-11
Understanding duty-cycle limitations	3-12

Controls and indicators

Powermax105 power supplies have the following: ON/OFF switch, adjustment knob, automatic/manual pressure setting mode selector, current/gas selector, operating mode switch, indicator LEDs, and a status screen. These controls and indicators are described on the following pages.

Rear controls

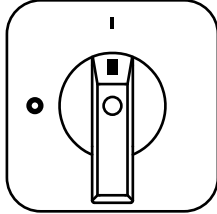

ON (I)/OFF (O) power switch

Activates the power supply and its control circuits.

Front controls and LEDs

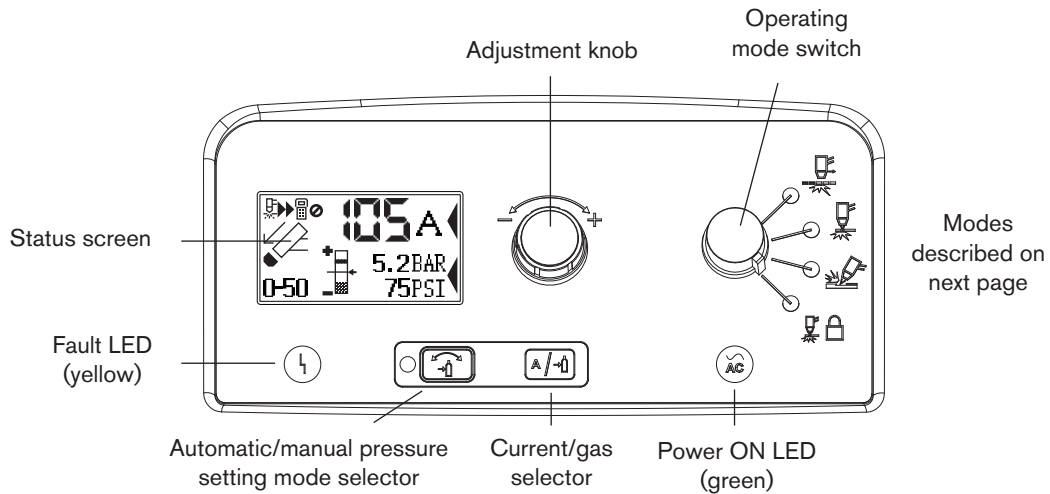

Fault LED (yellow)

When illuminated, this LED indicates that there is a fault with the power supply.



Power ON LED (green)

When illuminated, this LED indicates that the power switch has been set to I (ON) and that the safety interlocks are satisfied. When blinking, the power supply has a fault.

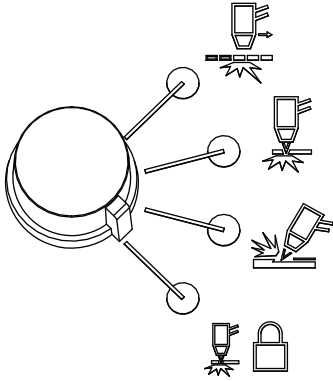
**Operating mode switch**

The operating mode switch can be set in one of four positions:

- Continuous pilot arc. Cuts expanded metal or grate.
- Non-continuous pilot arc. Cuts or pierces metal plate. This is the standard setting for normal drag-cutting.
- Gouge. Gouges metal plate.
- Torch lock. Same as the non-continuous pilot arc mode except the torch is locked in the ON position when you release the trigger during a cut. The torch goes out when the transfer is lost or the torch is retriggered.

**Automatic/manual pressure setting mode selector**

The selector switches between automatic and manual mode. In automatic mode, the power supply automatically sets the gas pressure based upon the torch type and lead length and the adjustment knob sets only the amperage. In manual mode, the adjustment knob sets either the gas pressure or the amperage. This LED is illuminated in manual mode.

Note: Manual mode should be used by experienced users who need to optimize the gas setting (override the automatic gas setting) for a specific cutting application.

When you switch from manual mode to automatic mode, the power supply automatically sets the gas pressure and the amperage setting is unchanged. When you switch from automatic mode to manual mode, the power supply remembers the previous manual gas pressure setting and the amperage setting is unchanged.

When you reset the power, the power supply remembers the previous mode, gas pressure, and amperage settings.

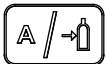
**Current/gas selector**

When in manual mode, this selector toggles between amperage and gas pressure for manual adjustments using the adjustment knob.

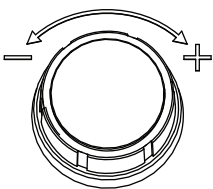
**Adjustment knob**

This knob adjusts the amperage. When operating in manual mode, this knob can also adjust the gas pressure, overriding the automatic setting for optimized applications.

Status screen

The status screen shows system status and fault information.

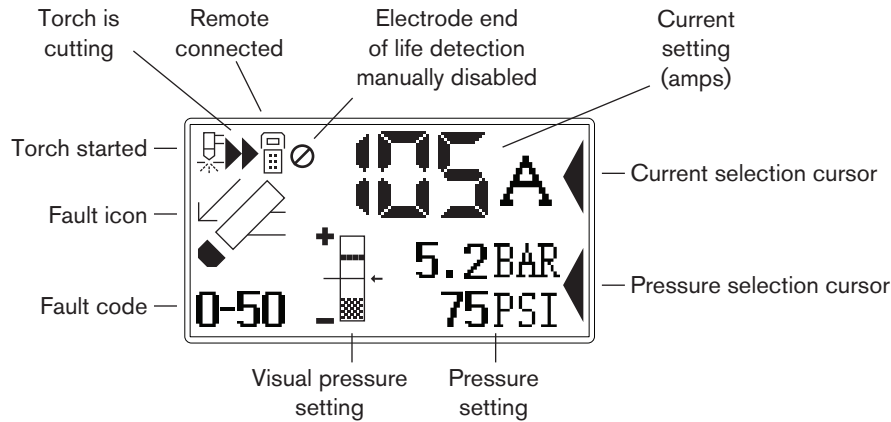

Gas pressure indicators

In manual mode, the gas pressure is displayed in bar and psi. The gas pressure bar is also a visual indicator of the gas pressure.

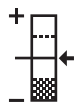

Gas pressure bar

When the arrow is centered in the vertical bar (the reference pressure of the automatic pressure setting), the gas pressure is set to the preset (factory-defined) value. If the pressure is higher than the preset value, the arrow appears above the mid-point of the bar. If the pressure is lower than the preset value, the arrow appears below the mid-point of the bar.

Note: In automatic mode, the power supply adjusts the pressure to the preset value. You can use manual mode to adjust the pressure to satisfy the needs of a particular cutting job. Refer to page 3-10 *Manually adjusting the gas pressure.*

System status icons

The screen displays icons to indicate the system's status.



Torch started

Indicates that the torch has received a start signal.



Torch is cutting

Indicates that the cutting arc has transferred to the metal and the torch is cutting.



Remote control

Indicates that a remote control or CNC is controlling the power supply using serial communications. All local controls are disabled.



Electrode end-of-life detection manually disabled

Indicates that the electrode end-of-life detection feature is manually disabled.

Fault codes

When a power supply or torch fault occurs, the system displays a fault code in the lower-left corner of the status screen and displays a corresponding fault icon above the code. The first digit is always zero. The other two digits identify the problem. Fault code information is included later in this manual.

Note: Only one fault code is displayed. If more than one fault occurs at the same time, only the fault code with the highest priority is displayed.

Fault icons

The fault icons that appear on the left side of the status screen are described below. A fault code also appears to identify the fault. Refer to the troubleshooting information later in this manual.



Warning

The system continues to run.



Fault

The system stops cutting. If you can not correct the problem and restart the system, contact your distributor or Hypertherm Technical Service.



Error

The system requires service. Contact your distributor or Hypertherm Technical Service.



Torch cap sensor

Indicates that the consumables are loose, improperly installed, or missing. Turn OFF the power, properly install the consumables, and turn ON the system again to reset the power supply.



Temperature

Indicates that the temperature of the power supply power module is outside the acceptable operating range.



Gas

Indicates that the gas is disconnected from the rear of the power supply or there is a problem with the gas supply.



Internal Serial Communications Interface

Indicates a problem with the SCl communications between the control board and the DSP board.

Operating the Powermax105

Follow the steps below to begin cutting or gouging with the Powermax system.

Note: This section provides basic operating instructions. Before operating your Powermax in a production environment, refer to the *Hand Torch Setup* section or the *Machine Torch Setup* section.

Connect the electrical power, gas supply, and torch lead

For information on connecting the proper plug to the power cord, refer to the *Power Supply Setup* section.

Plug in the power cord and connect the gas supply line. For more information about the electrical requirements and the gas supply requirements of the Powermax, see the *Power Supply Setup* section. To connect the torch, push the FastConnect™ connector into the receptacle on the front of the power supply. You will attach the work lead in the next section.

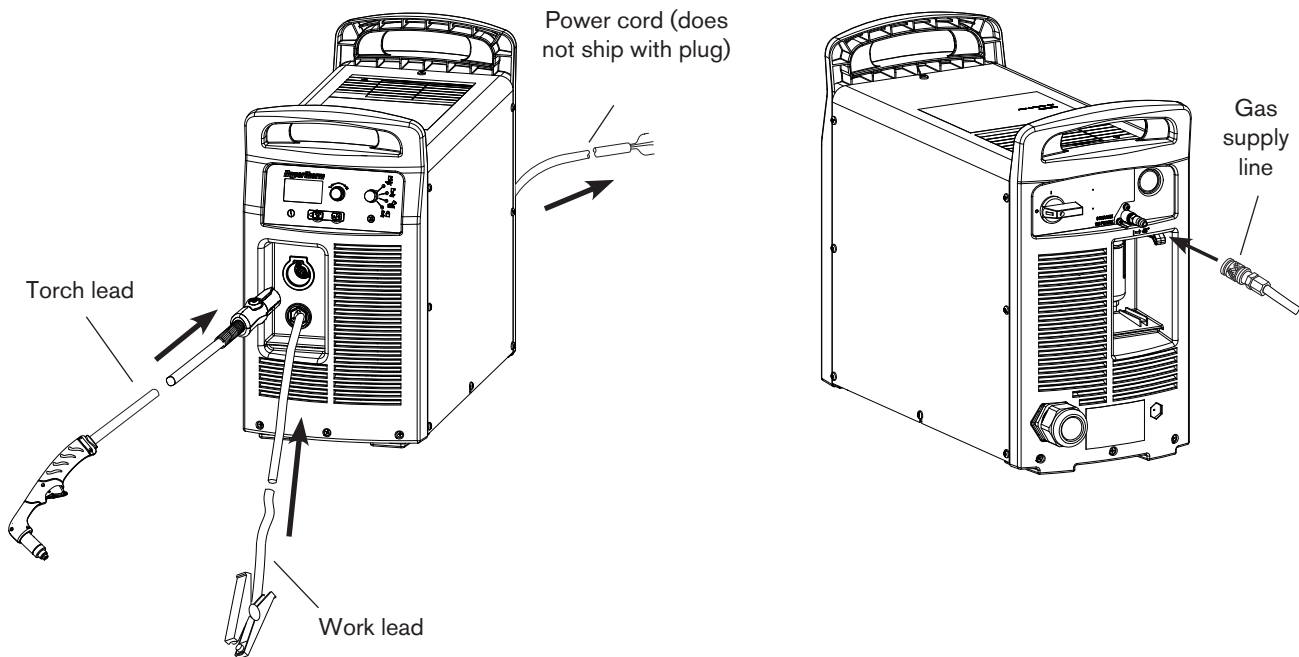

Attach the work lead to the power supply



Caution: Make sure you use a work lead that is appropriate for your power supply. Use a 105 A work lead with the Powermax105. The amperage is marked near the rubber boot of the work lead connector.

1. Insert the work lead connector into the receptacle on the front of the power supply.

Note: The receptacle is keyed. Align the key on the work lead connector with the opening at the top of the receptacle on the power supply.

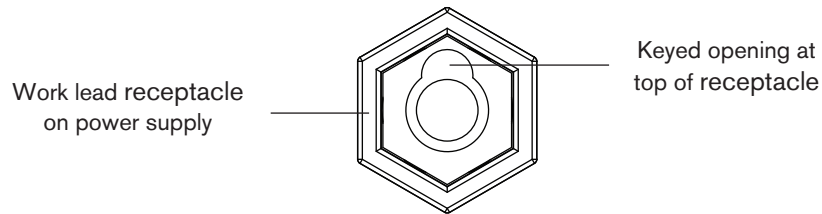

2. Push the work lead connector all the way into the receptacle on the power supply and turn clockwise, approximately 1/4 turn, until the connector is fully seated against the stop in order to achieve an optimal electrical connection.



Caution: Ensure the work lead is fully seated in the receptacle to prevent overheating.

Attach the work clamp to the workpiece

The work clamp must be connected to the workpiece while you are cutting. If you are using the Powermax105 with a cutting table, you can connect the work lead directly to the table instead of attaching the work clamp to the workpiece. See your table manufacturer's instructions.

Note the following:

- Ensure that the work clamp and the workpiece make good metal-to-metal contact. Remove rust, dirt, paint, coatings, and other debris to ensure the work lead makes proper contact with the workpiece.
- For the best cut quality, attach the work clamp as close as possible to the area being cut.



Caution: Do not attach the work clamp to the portion of the workpiece to be cut away.

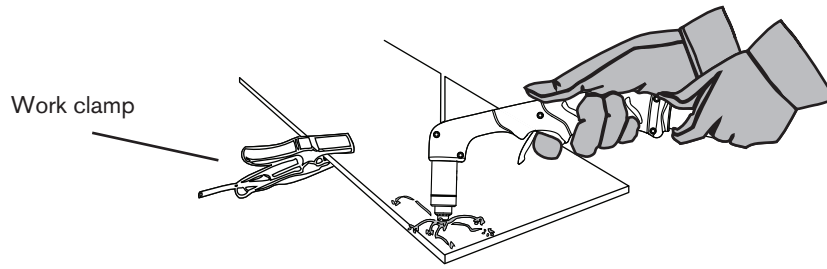

Turn ON the system

Set the ON/OFF switch to the ON (I) position.

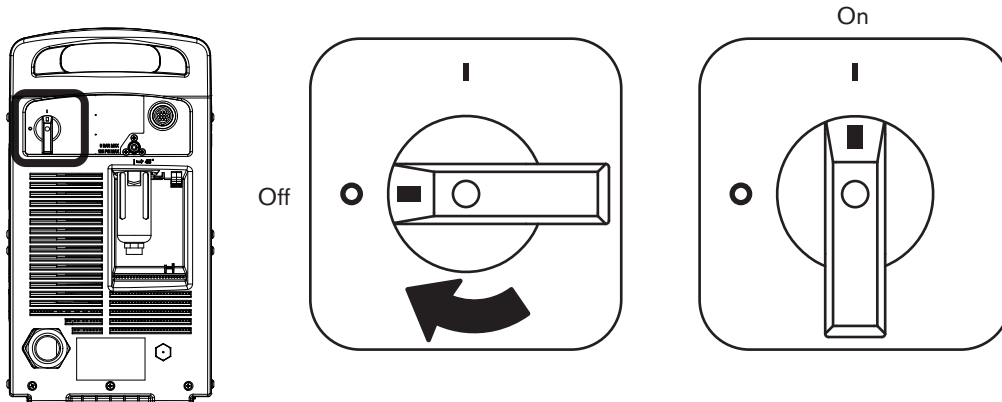

Set the operating mode switch

Use the operating mode switch to select the type of work you want to perform.

In automatic gas mode, Smart Sense™ technology automatically adjusts the gas pressure according to the selected cutting mode and torch lead length for optimum cutting.

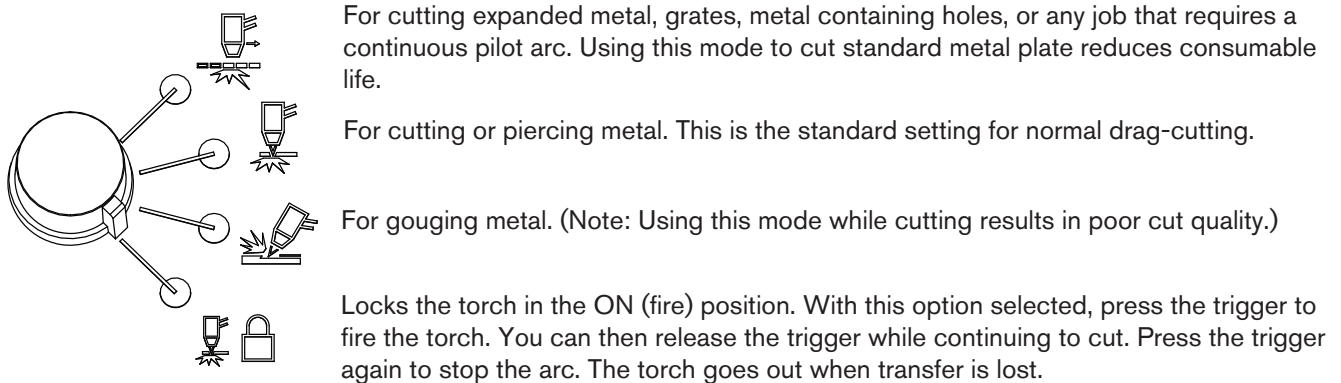

Check the indicators

Verify the following:

- The green power ON LED on the front of the power supply is illuminated.
- The Fault LED is *not* illuminated.
- No error icons appear in the status screen.

If a fault icon appears in the status screen, or the Fault LED is illuminated, or the power ON LED is blinking, correct the fault condition before continuing. More troubleshooting information is included later in this manual.

Manually adjusting the gas pressure

For normal operations, the power supply automatically adjusts the gas pressure. If you need to adjust the gas pressure for a specific application, you can use manual mode to do so.

Note: Manual mode should be used by experienced users who need to optimize the gas setting (override the automatic gas setting) for a specific cutting application.

When you switch from manual mode to automatic mode, the power supply automatically sets the gas pressure and the amperage setting is unchanged. When you switch from automatic mode to manual mode, the power supply remembers the previous manual gas pressure setting and the amperage setting is unchanged.

When you reset the power, the power supply remembers the previous mode, gas pressure, and amperage settings.

To adjust the pressure:

1. Press the automatic/manual pressure setting mode selector so that the LED next to the selector illuminates. Refer to the diagram on page 3-2 *Front controls and LEDs*.
2. Press the current/gas selector until the selection cursor is opposite the gas pressure setting in the status screen.
3. Turn the adjustment knob to adjust the gas pressure to the desired level. Watch the arrow in the pressure bar as you adjust the pressure.

Adjusting the current (amperage)

Turn the adjustment knob to adjust the current for your particular cutting application.

If the system is in manual mode, do the following to adjust the amperage.

1. Press the current/gas selector until the selection cursor is opposite the amperage setting in the status screen.
2. Turn the adjustment knob to change the amperage.
3. If you wish to exit manual mode, press the automatic/manual pressure setting mode selector. The LED goes off.

Note: When you exit manual mode, the gas pressure resets to the factory-optimized value.

When you switch between manual mode and automatic mode, the power supply retains the amperage setting. When you reset the power, the power supply returns to the previous mode (automatic mode or manual mode) and remembers the previous amperage setting.

Electrode end-of-life detection feature

The electrode end-of-life detection feature on the Powermax105 protects the torch and workpiece from damage by automatically stopping power to the torch when the electrode reaches its end of life. Fault code 0-32 also displays on the front panel status screen. If you have the current set below 55 A, this feature is automatically disabled without displaying the icon on the status screen.

To manually disable the feature, press the current/gas selector button (see figure below) five times on the control panel. The system must be in the auto mode and the selector presses must be less than one second apart. Re-enable the feature by repeating this procedure. An icon (see figure below) displays on the status screen when the feature is manually disabled.

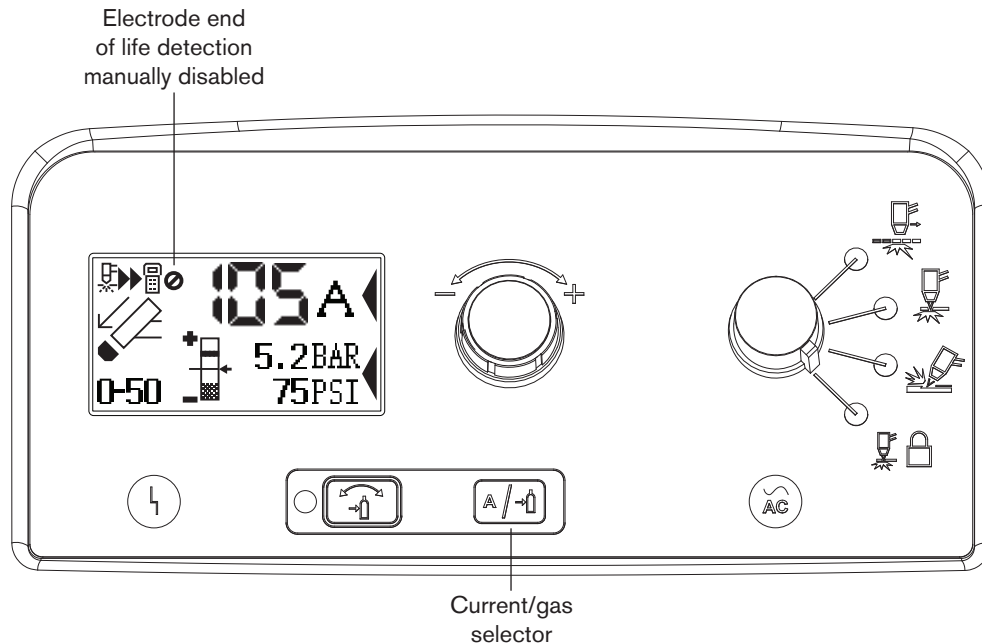

Understanding duty-cycle limitations

The duty cycle is the amount of time, in minutes, that a plasma arc can remain on within a 10-minute period when operating at an ambient temperature of 40° C (104° F).

With a Powermax105:

- At 105 A (480-600 V CSA, 400 V CE, 380 V CCC), the arc can remain on for 8 minutes out of 10 minutes without causing the unit to overheat (80% duty cycle).
- At 94 A (480-600 V CSA, 400 V CE, 380 V CCC), the arc can remain on for 10 minutes out of 10 (100%).

See the *Specifications* section for a complete list of duty cycle specifications.

If the duty cycle is exceeded, the power supply overheats, the temperature fault icon appears in the status screen, the arc shuts off, and the cooling fan continues to run. You can not resume cutting until the temperature fault icon disappears and the fault LED goes off.

Section 4

HAND TORCH SETUP

In this section:

Introduction	4-2
Consumable life.....	4-2
Hand torch components	4-3
Choose the hand torch consumables.....	4-4
Drag-cutting 105 A consumables	4-4
Drag-cutting 45 A, 65 A, 85 A consumables	4-4
Hand torch consumables.....	4-5
Gouging consumables	4-5
FineCut® consumables.....	4-5
Install the hand torch consumables.....	4-6
Connecting the torch lead.....	4-7

Introduction

Duramax™ series hand torches are available for Powermax105 systems. The FastConnect™ quick-disconnect system makes it easy to remove the torch for transport or to switch from one torch to the other if your applications require the use of different torches. The torches are cooled by ambient air and do not require special cooling procedures.

This section explains how to set up your hand torch and choose the appropriate consumables for the job.

Consumable life

How often you need to change the consumables on your torch will depend on a number of factors:

- The thickness of the metal being cut.
- The average length of the cut.
- The air quality (presence of oil, moisture, or other contaminants).
- Whether you are piercing the metal or starting cuts from the edge.
- Proper torch-to-work distance when gouging or cutting with unshielded consumables.
- Proper pierce height.
- Whether you are cutting in “continuous pilot arc” mode or normal mode. Cutting with a continuous pilot arc causes more consumable wear.

Under normal conditions, the nozzle will wear out first when hand cutting. As general rule, a set of consumables lasts approximately 1 to 3 hours of actual “arc on” time for hand cutting.

You will find more information about proper cutting techniques in the *Hand Cutting* section.

Hand torch components

Note: Torches ship without consumables installed.

Duramax 75° hand torch

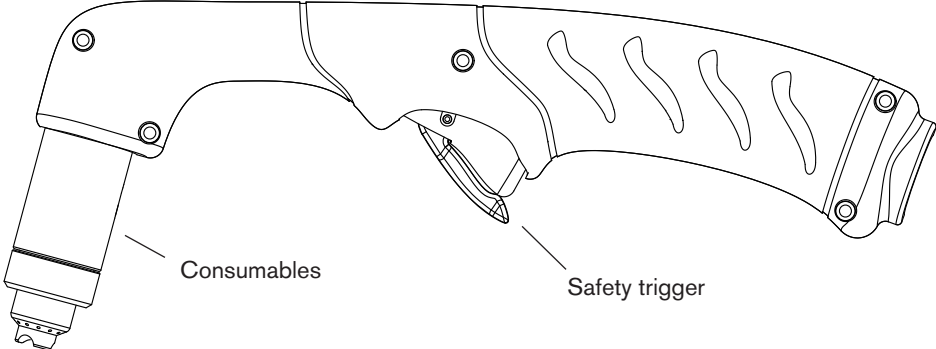

Duramax 15° hand torch

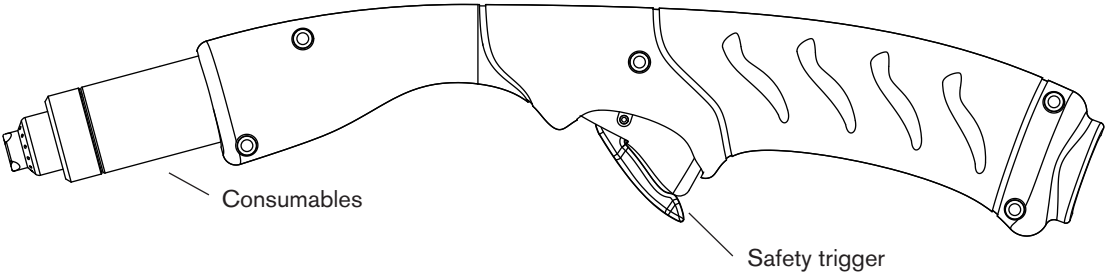

Choose the hand torch consumables

Hypertherm includes a box of consumables with your system. Both styles of hand torches shown on the previous page use the same consumables.

Hand torches use shielded consumables. Therefore, you can drag the torch tip along the metal.

Consumables for hand cutting are shown on the next page. Notice that the retaining cap and electrode are the same for cutting, gouging, and FineCut® applications. Only the shield, nozzle, and swirl ring are different.

For the best cut quality on thin materials (approximately 4mm/10GA or less), you may prefer to use FineCut consumables, or use a 45 A nozzle and reduce the amperage to that setting.

Drag-cutting 105 A consumables

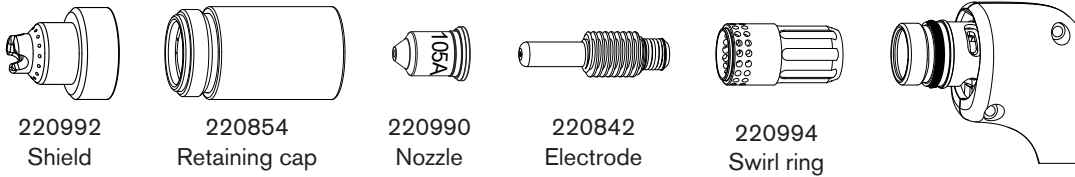

Drag-cutting 45 A, 65 A, 85 A consumables

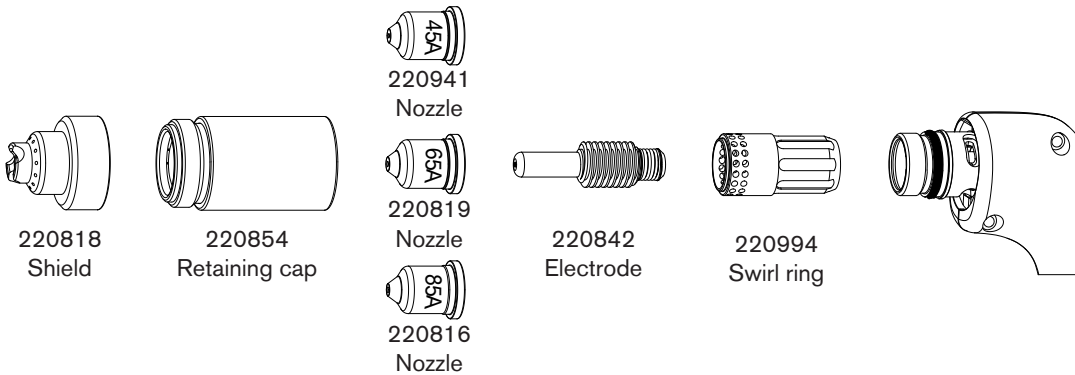

Hand torch consumables

Gouging consumables

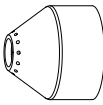

220798
Shield

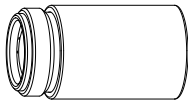

220854
Retaining cap



220991
Nozzle

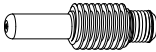

220842
Electrode

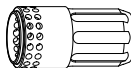

220994
Swirl ring

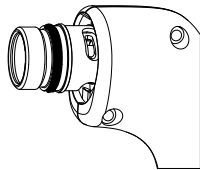

FineCut® consumables

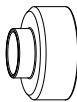

220931
Shield

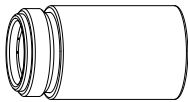

220854
Retaining cap



220930
Nozzle

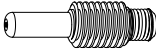

220842
Electrode

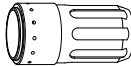

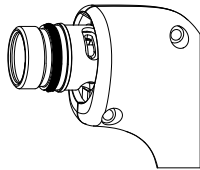

220947
Swirl ring



HAND TORCH SETUP

Install the hand torch consumables

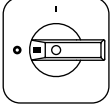
		WARNING: INSTANT-ON TORCHES PLASMA ARC CAN CAUSE INJURY AND BURNS
	The plasma arc comes on immediately when the torch trigger is activated. Make sure the power is OFF before changing consumables.	

To operate the hand torch, a complete set of consumable parts must be installed: shield, retaining cap, nozzle, electrode, and swirl ring. Torches ship without consumables installed. Pull off the vinyl cap before installing your consumables.

With the power switch in the OFF (O) position, install the torch consumables as shown below.

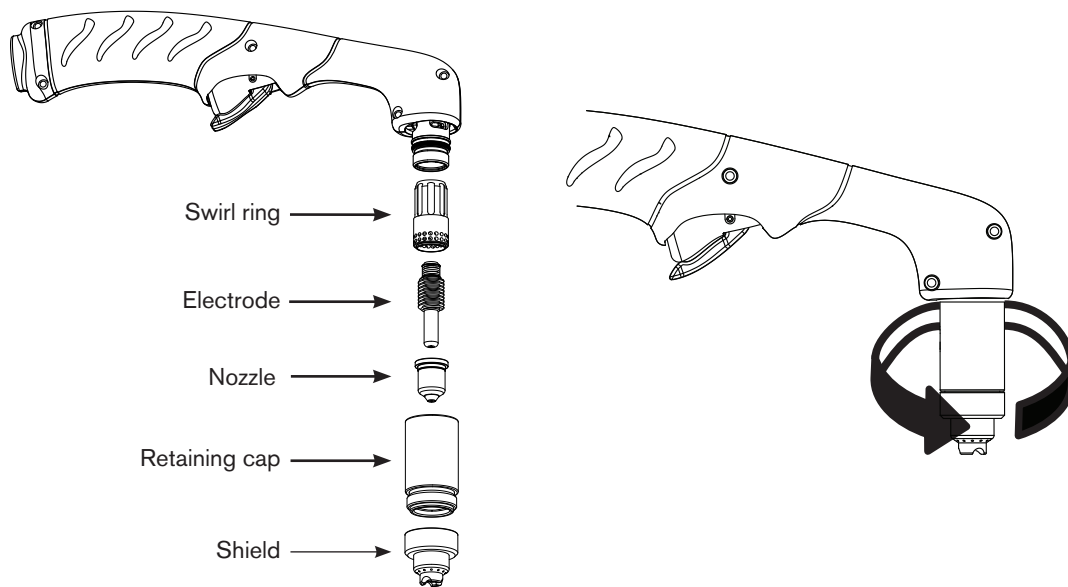

Connecting the torch lead

The Powermax105 is equipped with FastConnect™, a quick-disconnect system for connecting and disconnecting handheld and machine torch leads. When connecting or disconnecting a torch, first turn OFF the system. To connect the torch, push the connector into the receptacle on the front of the power supply.

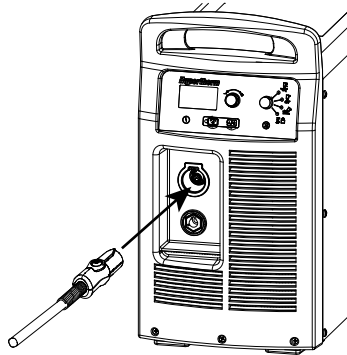

To remove the torch, press the red button on the connector and pull the connector out of the receptacle.

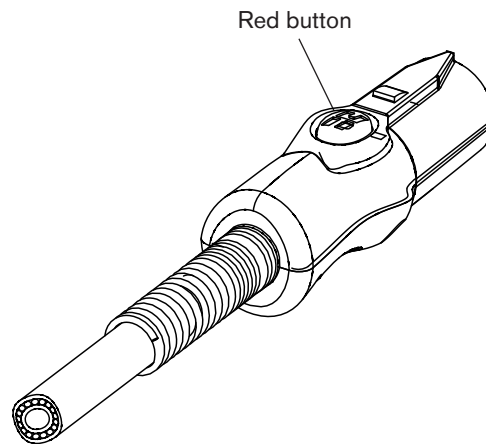



Section 5

HAND CUTTING

In this section:

Using the hand torch.....	5-2
Operate the safety trigger.....	5-2
Hand torch cutting hints.....	5-3
Start a cut from the edge of the workpiece.....	5-4
Pierce a workpiece.....	5-5
Gouge a workpiece.....	5-6
Gouge profile.....	5-7
Varying the gouge profile.....	5-8
Common hand-cutting faults.....	5-8

Using the hand torch

		<p style="text-align: center;">WARNING INSTANT-ON TORCHES PLASMA ARC CAN CAUSE INJURY AND BURNS</p>
<p>Plasma arc comes on immediately when the torch trigger is activated. The plasma arc will cut quickly through gloves and skin.</p> <ul style="list-style-type: none">▪ Wear correct and appropriate protective equipment.▪ Keep away from the torch tip.▪ Do not hold the workpiece and keep your hands clear of the cutting path.▪ Never point the torch toward yourself or others.		

Operate the safety trigger

The hand torches are equipped with a safety trigger to prevent accidental firings. When you are ready to use the torch, flip the trigger's safety cover forward (toward the torch head) and press the red torch trigger as show below.

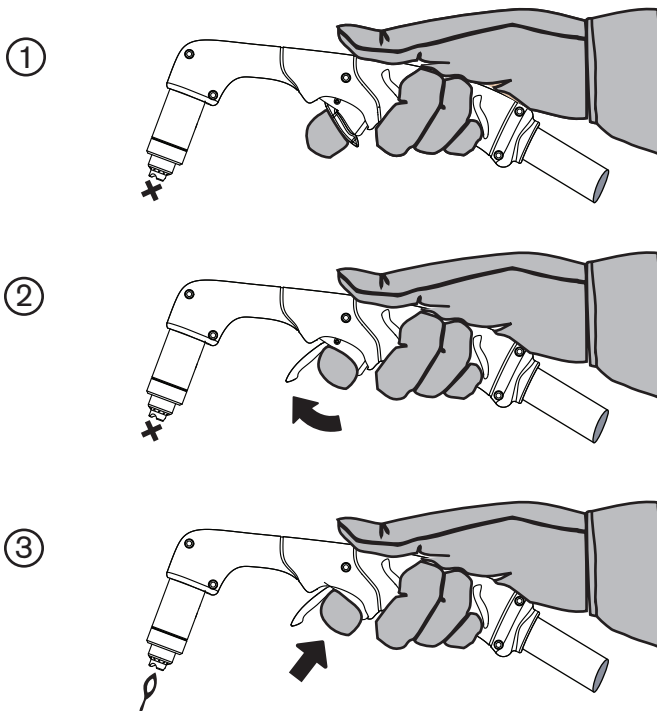

Hand torch cutting hints

- Drag the torch tip lightly along the workpiece to maintain a steady cut.
- While cutting, make sure that sparks exit from the bottom of the workpiece. The sparks should lag slightly behind the torch as you cut (15° — 30° angle from vertical).
- If sparks spray up from the workpiece, move the torch more slowly, or set the output current higher.
- With either the Duramax 75° hand torch or Duramax 15° hand torch, hold the torch nozzle perpendicular to the workpiece so that the nozzle is at a 90° angle to the cutting surface. Observe the cutting arc as the torch cuts.

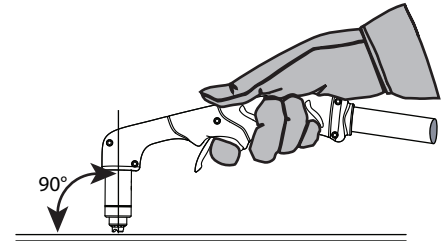

- If you fire the torch unnecessarily, you will shorten the life of the nozzle and electrode.

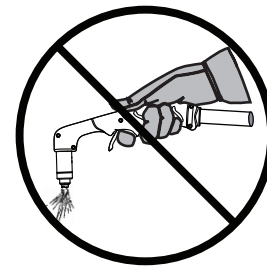

- Pulling, or dragging, the torch along the cut is easier than pushing it.
- For straight-line cuts, use a straight edge as a guide. To cut circles, use a template or a radius cutter attachment (a circle cutting guide). See the *Parts* section for part numbers for the Hypertherm plasma cutting guides for cutting circles and making bevel cuts.

Start a cut from the edge of the workpiece

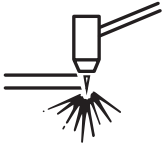

1. With the work clamp attached to the workpiece, hold the torch nozzle perpendicular (90°) to the edge of the workpiece.



2. Press the torch's trigger to start the arc. Pause at the edge until the arc has cut completely through the workpiece.



3. Drag the torch tip lightly across the workpiece to proceed with the cut. Maintain a steady, even pace.



Pierce a workpiece

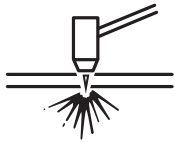

		WARNING
<p>SPARKS AND HOT METAL CAN INJURE EYES AND BURN SKIN. When firing the torch at an angle, sparks and hot metal will spray out from the nozzle. Point the torch away from yourself and others.</p>		

1. With the work clamp attached to the workpiece, hold the torch at an approximate 30° angle to the workpiece with the torch tip within 1.5 mm (1/16 inch) of the workpiece before firing the torch.
2. Fire the torch while still at an angle to the workpiece. Slowly rotate the torch to a perpendicular (90°) position.
3. Hold the torch in place while continuing to press the trigger. When sparks exit below the workpiece, the arc has pierced the material.
4. When the pierce is complete, drag the nozzle lightly along the workpiece to proceed with the cut.



Gouge a workpiece



WARNING

SPARKS AND HOT METAL CAN INJURE EYES AND BURN SKIN. When firing the torch at an angle, sparks and hot metal will spray out from the nozzle. Point the torch away from yourself and others.

1. Hold the torch so that the torch tip is within 1.5 mm (1/16 inch) from the workpiece before firing the torch.

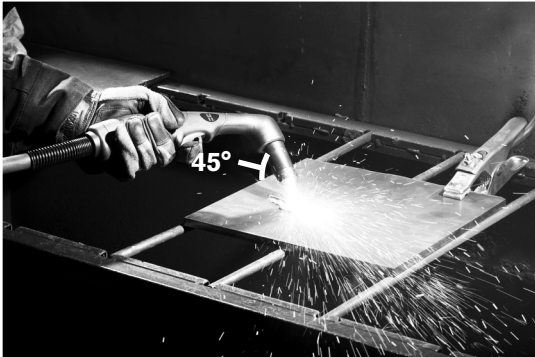

2. Hold the torch at a 45° angle to the workpiece with a small gap between the torch tip and the workpiece. Press the trigger to obtain a pilot arc. Transfer the arc to the work piece.



3. Maintain an approximate 45° angle to the workpiece as you feed into the gouge. Push the plasma arc in the direction of the gouge you want to create. Keep a small distance between the torch tip and the molten metal to avoid reducing consumable life or damaging the torch.

Changing the torch's angle changes the dimensions of the gouge.

Gouge profile

You can vary the gouge profile by varying the speed of the torch over the workpiece, varying the torch-to-work standoff distance, varying the angle of the torch to the workpiece, and varying the current output of the power supply.

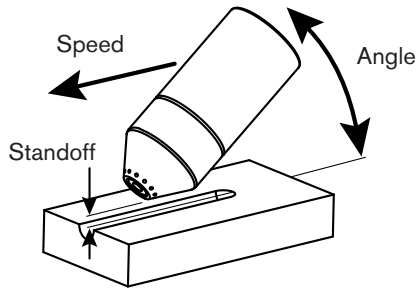

Operating parameters	
Speed	50.8-63.5 cm/min (20-25 ipm)
Standoff	6.4-9.5 mm (1/4-3/8 in.)
Angle	35-40°

Typical Gouge Profile for 65 A

Metal removal rate on mild steel
4.8 kg/hr (10.7 lbs/hr)

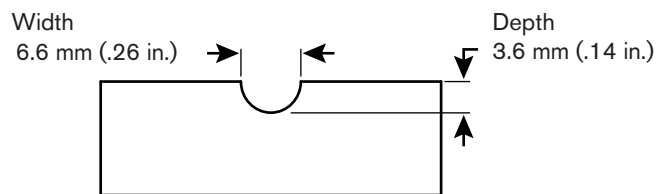

Typical Gouge Profile for 85 A

Metal removal rate on mild steel
8.8 kg/hr (19.5 lbs/hr)

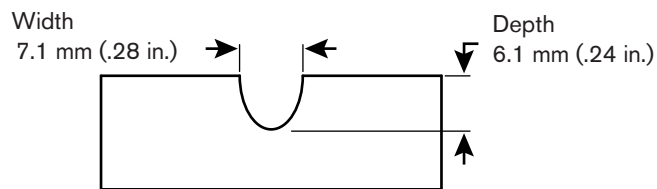

Typical Gouge Profile for 105 A

Metal removal rate on mild steel
9.8 kg/hr (21.7 lbs/hr)

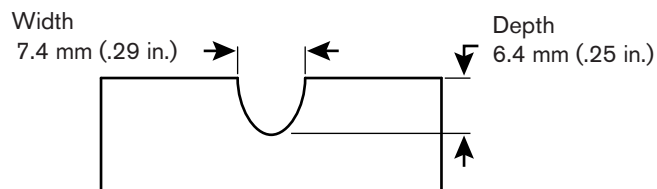

Varying the gouge profile

The following actions have the stated effects on the gouge profile:

- **Increasing the speed** of the torch will **decrease width** and **decrease depth**.
- **Decreasing the speed** of the torch will **increase width** and **increase depth**.
- **Increasing the standoff** of the torch will **increase width** and **decrease depth**.
- **Decreasing the standoff** of the torch will **decrease width** and **increase depth**.
- **Increasing the angle** of the torch (more vertical) will **decrease width** and **increase depth**.
- **Decreasing the angle** of the torch (less vertical) will **increase width** and **decrease depth**.
- **Increasing the current** of the power supply will **increase width** and **increase depth**.
- **Decreasing the current** of the power supply will **decrease width** and **decrease depth**.

Common hand-cutting faults

The torch does not cut completely through the workpiece. The causes can be:

- The cut speed is too fast.
- The consumables are worn.
- The metal being cut is too thick for the selected amperage.
- Gouging consumables are installed instead of drag-cutting consumables.
- The work clamp is not attached properly to the workpiece.
- The gas pressure or gas flow rate is too low.

Cut quality is poor. The causes can be:

- The metal being cut is too thick for the amperage.
- The wrong consumables are being used (gouging consumables are installed instead of drag-cutting consumables, for example).
- You are moving the torch too quickly or too slowly.

The arc sputters and consumables life is shorter than expected. The cause can be:

- Moisture in the gas supply.
- Incorrect gas pressure.
- Consumables incorrectly installed.

MACHINE TORCH SETUP

In this section:

Introduction	6-3
Consumable life.....	6-3
Machine torch components.....	6-4
Converting a full-length machine torch to a mini machine torch	6-5
Mount the torch	6-7
Choose the machine torch consumables.....	6-9
Machine torch consumables	6-9
Mechanized shielded 105 A consumables	6-9
Mechanized shielded 45 A, 65 A, 85 A consumables	6-9
Mechanized shielded with ohmic 105 A consumables	6-10
Mechanized shielded with ohmic 45 A, 65 A, 85 A consumables	6-10
Mechanized unshielded 105 A consumables.....	6-10
Mechanized unshielded 45 A, 65 A, 85 A consumables.....	6-10
Gouging consumables	6-11
FineCut® shielded consumables.....	6-11
FineCut® unshielded consumables	6-11
Install the machine torch consumables.....	6-12
Aligning the torch.....	6-12
Connecting the torch lead.....	6-13
Using the cut charts	6-14
Estimated kerf-width compensation.....	6-15
105 A Shielded consumables	6-17
105 A Shielded cutting (Mild Steel)	6-18
105 A Shielded cutting (Stainless Steel)	6-19
105 A Shielded cutting (Aluminum).....	6-20
85 A Shielded consumables.....	6-21
85 A Shielded cutting (Mild Steel).....	6-22
85 A Shielded cutting (Stainless Steel).....	6-23
85 A Shielded cutting (Aluminum)	6-24

MACHINE TORCH SETUP

65 A Shielded consumables.....	6-25
65 A Shielded cutting (Mild Steel).....	6-26
65 A Shielded cutting (Stainless Steel).....	6-27
65 A Shielded cutting (Aluminum).....	6-28
45 A Shielded consumables.....	6-29
45 A Shielded cutting (Mild Steel).....	6-30
45 A Shielded cutting (Stainless Steel).....	6-31
45 A Shielded cutting (Aluminum).....	6-32
FineCut® consumables.....	6-33
FineCut (Mild Steel).....	6-34
FineCut (Stainless Steel).....	6-35
Low Speed FineCut (Mild Steel).....	6-36
Low Speed FineCut (Stainless Steel).....	6-37
105 A Unshielded consumables.....	6-38
105 A Unshielded cutting (Mild Steel).....	6-39
105 A Unshielded cutting (Stainless Steel).....	6-40
105 A Unshielded cutting (Aluminum).....	6-41
85 A Unshielded consumables.....	6-42
85 A Unshielded cutting (Mild Steel).....	6-43
85 A Unshielded cutting (Stainless Steel).....	6-44
85 A Unshielded cutting (Aluminum).....	6-45
65 A Unshielded consumables.....	6-46
65 A Unshielded cutting (Mild Steel).....	6-47
65 A Unshielded cutting (Stainless Steel).....	6-48
65 A Unshielded cutting (Aluminum).....	6-49
45 A Unshielded consumables.....	6-50
45 A Unshielded cutting (Mild Steel).....	6-51
45 A Unshielded cutting (Stainless Steel).....	6-52
45 A Unshielded cutting (Aluminum).....	6-53

Introduction

Duramax™ series machine torches are available for Powermax105 systems. The FastConnect™ quick-disconnect system makes it easy to remove the torch for transport or to switch from one torch to the other if your applications require the use of different torches. The torches are cooled by ambient air and do not require special cooling procedures.

This section explains how to set up your machine torch and choose the appropriate consumables for the job.

Consumable life

How often you need to change the consumables on your torch will depend on a number of factors:

- The thickness of the metal being cut.
- The average length of the cut.
- The air quality (presence of oil, moisture, or other contaminants).
- Whether you are piercing the metal or starting cuts from the edge.
- Proper torch-to-work distance when gouging or cutting with unshielded consumables.
- Proper pierce height.
- Whether you are cutting in “continuous pilot arc” mode or normal mode. Cutting with a continuous pilot arc causes more consumable wear.

Under normal conditions, the electrode will wear out first during machine cutting. As general rule, a set of consumables should last about 1 to 5 hours for mechanized cutting, depending upon the job.

You will find more information about proper cutting techniques in the *Mechanized Cutting* section.

Machine torch components

Duramax 180° full-length machine torch

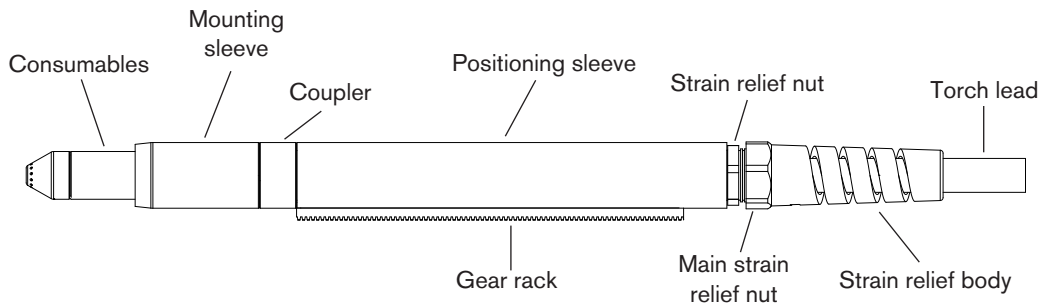

Duramax 180° mini machine torch

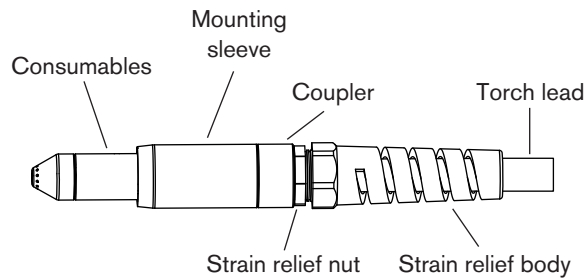

Before using either style of machine torch, you must:

- Mount the torch on your cutting table or other equipment.
- Choose and install the consumables.
- Align the torch square to the plate.
- Attach the torch lead to the power supply.
- Set up the power supply for remote starting with either the remote-start pendant or a machine interface cable.

Converting a full-length machine torch to a mini machine torch

You can convert a full-length machine torch to a mini machine torch by removing the positioning sleeve.

Note: If you are converting a full-length machine torch to a mini machine torch *and* mounting the torch at the same time, skip this section and follow the instructions on page 6-7 *Mount the torch*.

Refer to the figures on page 6-4 *Machine torch components* and follow these instructions.

Note: While disconnecting and reconnecting the torch parts, maintain the same orientation between the torch head and torch lead. Twisting the torch head in relation to the torch lead can cause damage.

1. Disconnect the torch lead from the power supply and remove the consumables from the torch.
2. Unscrew the strain relief body from the strain relief nut and slide the strain relief body back along the torch lead.
3. Unscrew the strain relief nut from the positioning sleeve and slide the nut back along the torch lead.
4. Unscrew the positioning sleeve from the coupler.
5. Unscrew the coupler from the mounting sleeve.
6. Remove the three screws from the consumables end of the mounting sleeve and slide the mounting sleeve off the front of the torch body.

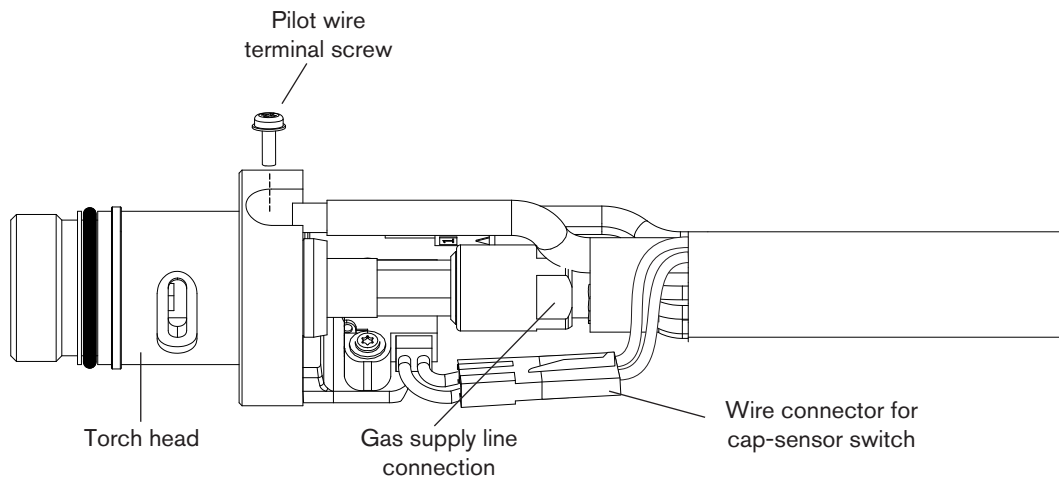

MACHINE TORCH SETUP

7. Disconnect the wire connector for the cap-sensor switch.
8. Use a #2 Phillips screwdriver to remove the screw that secures the torch's pilot wire to the torch body.
9. Use 1/4-inch and 3/8-inch wrenches, or adjustable wrenches, to loosen the nut that secures the gas supply line to the torch lead. Set the torch body aside.
10. Slide the coupler and positioning sleeve off the front of the torch lead.
11. Slide the coupler over the torch lead.
12. Reconnect the gas line to the torch lead.
13. Reattach the torch's pilot wire to the torch body using the screw.
14. Reconnect the cap-sensor switch's wire connector.
15. Slide the mounting sleeve over the front of the torch body. Align the slot on the front of the mounting sleeve (next to one of the three screw holes) with the cap-sensor plunger on the torch body.
16. Attach the mounting sleeve to the torch body using the three screws.
17. Screw the coupler into the mounting sleeve.
18. Screw the strain relief nut into the coupler.
19. Screw the strain relief body into the strain relief nut.

Mount the torch

Depending on the type of cutting table you have, you may or may not need to disassemble the torch to route it through the track and mount it. If your cutting table's track is large enough for you to thread the torch through it without removing the torch body from the lead, do so and then attach the torch to the lifter per the manufacturer's instructions.

Note: The Duramax machine torches can be mounted on a wide variety of X-Y tables, track burners, pipe bevelers, and other equipment. Install the torch per the manufacturer's instructions and follow the instructions below for disassembly if necessary.

If you need to disassemble and reassemble the torch, refer to the figures on page 6-4 *Machine torch components* and follow these instructions.

Note: While disconnecting and reconnecting the torch parts, maintain the same orientation between the torch head and torch lead. Twisting the torch head in relation to the torch lead can cause damage.

1. Disconnect the torch lead from the power supply and remove the consumables from the torch.
2. Unscrew the strain relief body from the strain relief nut and slide the strain relief body back along the torch lead.
3. Unscrew the strain relief nut from the positioning sleeve (full-length machine torch) and slide the nut back along the torch lead.
4. Unscrew the positioning sleeve from the coupler.
5. Unscrew the coupler from the mounting sleeve.
6. Remove the three screws from the consumables end of the mounting sleeve and slide the mounting sleeve off the front of the torch body.

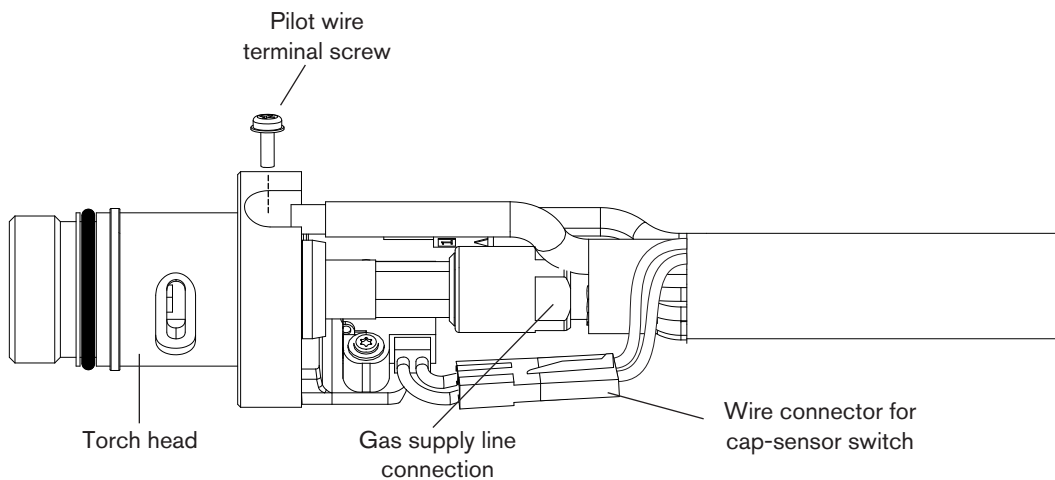

MACHINE TORCH SETUP

7. Disconnect the wire connector for the cap-sensor switch.
8. Use a #2 Phillips screwdriver to remove the screw that secures the torch's pilot wire to the torch body.
9. Use 1/4-inch and 3/8-inch wrenches, or adjustable wrenches, to loosen the nut that secures the gas supply line to the torch lead. Set the torch body aside.

Note: Cover the end of the gas line on the torch lead with tape to keep dirt and other contaminants from getting in the gas line when you route the lead through the track.
10. Slide the coupler, positioning sleeve (full-length machine torch), strain relief nut, and strain relief body off the front of the torch lead.
11. If you do not need the gear rack on a full-length machine torch, slide the gear rack from the positioning sleeve toward the consumables end of the sleeve.
12. Route the torch lead through the cutting table's track.
13. Slide the strain relief body and strain relief nut over the torch lead.
14. If you are mounting a full-length machine torch, slide the positioning sleeve over the torch head. If you are mounting a mini machine torch, set aside the positioning sleeve.
15. Slide the coupler over the torch lead.
16. Reconnect the gas line to the torch lead.
17. Reattach the torch's pilot wire to the torch body using the screw.
18. Reconnect the cap-sensor switch's wire connector.
19. Slide the mounting sleeve over the front of the torch body. Align the slot on the front of the mounting sleeve (next to one of the three screw holes) with the cap-sensor plunger on the torch body.
20. Attach the mounting sleeve to the torch body using the three screws.
21. Screw the coupler into the mounting sleeve.
22. If you are mounting a full-length machine torch, screw the positioning sleeve into the coupler. If you are mounting a mini machine torch, the strain relief nut attaches directly to the coupler in the next step.
23. Reconnect the strain relief nut and strain relief body.
24. Attach the torch to the lifter per the manufacturer's instructions.

Choose the machine torch consumables

Powermax systems with the Duramax 180° full-length machine torch or Duramax 180° mini machine torch are shipped with a box of consumables. In addition, an ohmic-sensing retaining cap is available for use with shielded consumables.

With shielded consumables, the torch tip may touch the metal when cutting. With unshielded consumables, you must keep the torch a small distance, about 2-3 mm (.08-.12 inch), away from the metal. Unshielded consumables generally have a shorter life than shielded consumables. Depending upon which system you order, you may receive a starter consumable kit with a standard retaining cap or ohmic retaining cap.

Both styles of machine torches use the same consumables.

Machine torch consumables

Mechanized shielded 105 A consumables

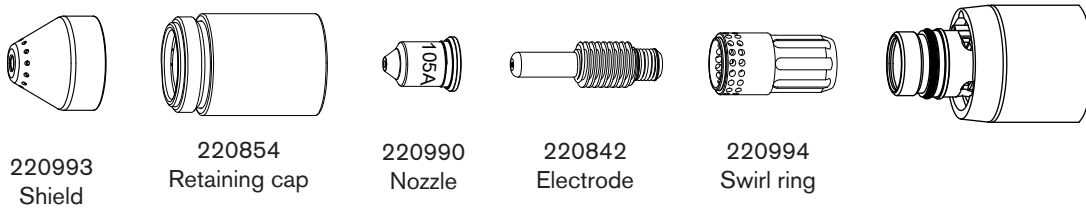

Mechanized shielded 45 A, 65 A, 85 A consumables

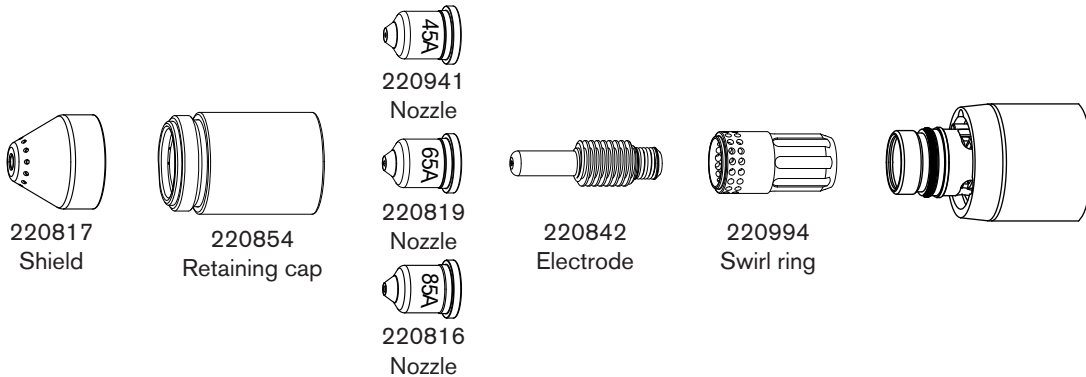

MACHINE TORCH SETUP

Mechanized shielded with ohmic 105 A consumables

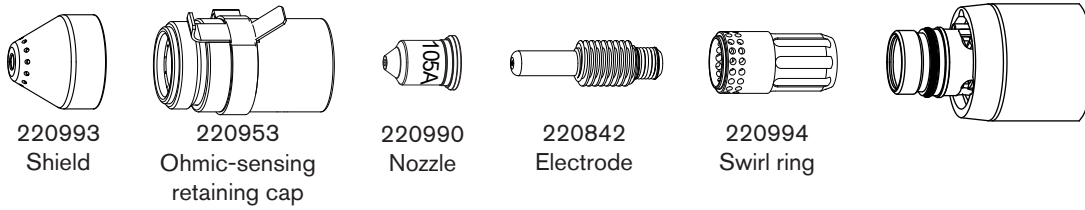

Mechanized shielded with ohmic 45 A, 65 A, 85 A consumables

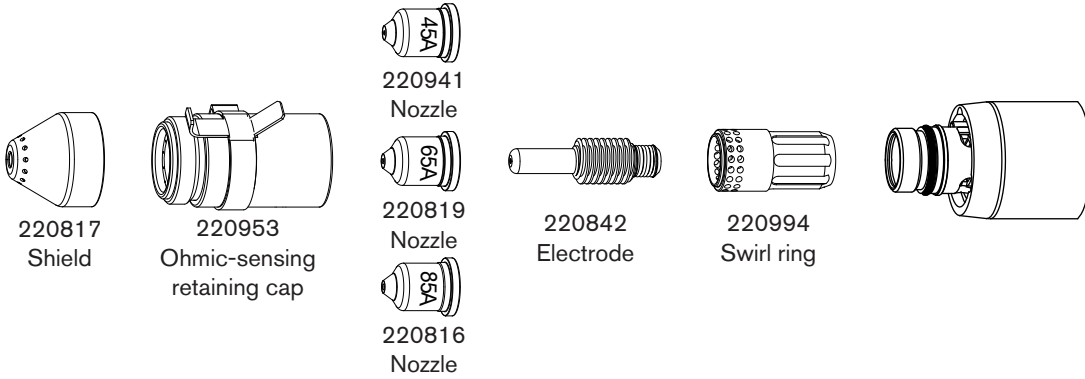

Mechanized unshielded 105 A consumables

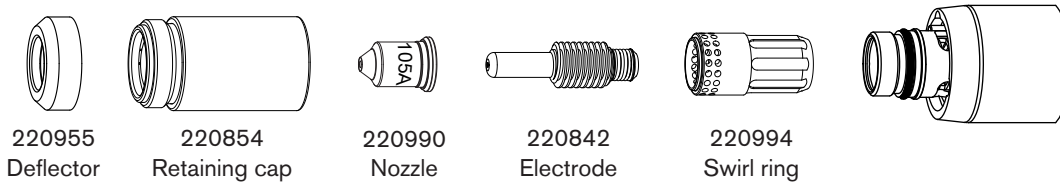

Mechanized unshielded 45 A, 65 A, 85 A consumables

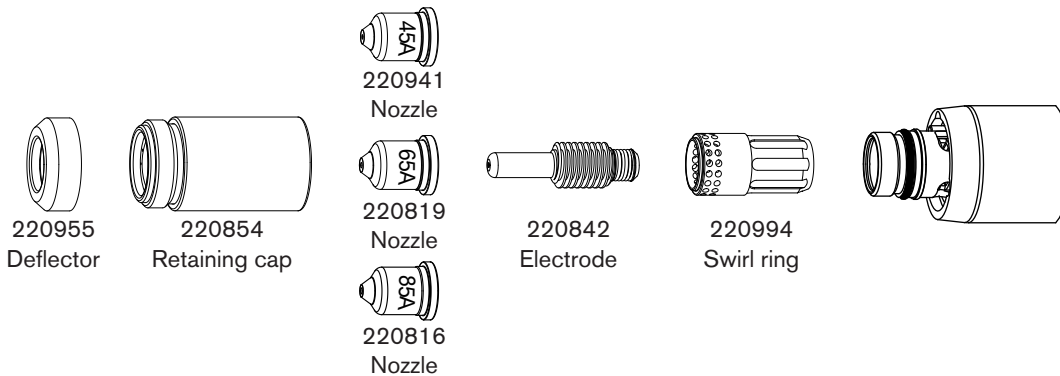

Gouging consumables

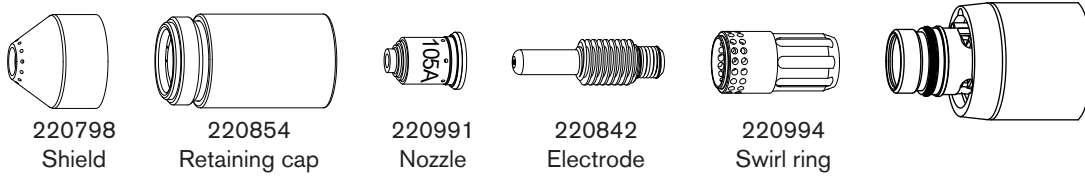

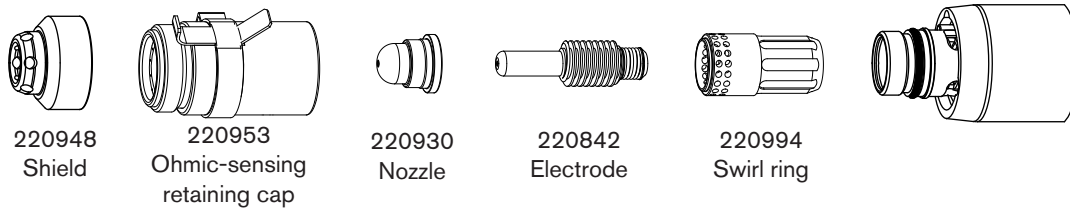

FineCut® shielded consumables

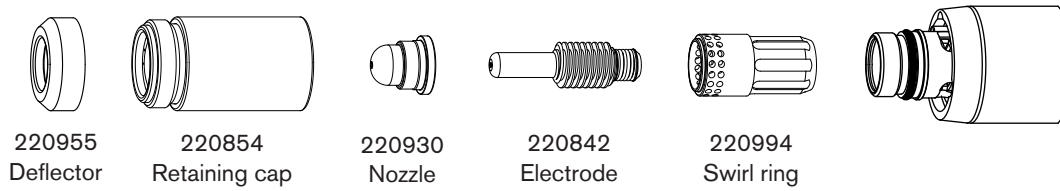

FineCut® unshielded consumables

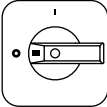

Install the machine torch consumables

		<p>WARNING INSTANT-ON TORCHES PLASMA ARC CAN CAUSE INJURY AND BURNS</p>
	<p>The plasma arc comes on immediately when the torch is activated. Make sure the power is OFF before changing the consumables.</p>	

To operate the machine torch, a complete set of consumable parts must be installed: shield, retaining cap, nozzle, electrode, and swirl ring.

With the power switch in the OFF (O) position, install the machine torch consumables in a manner similar to the hand torch consumables. Refer to the *Hand torch setup* section.

Aligning the torch

Mount the machine torch perpendicular to the workpiece in order to get a vertical cut. Use a square to align the torch at 0° and 90°.

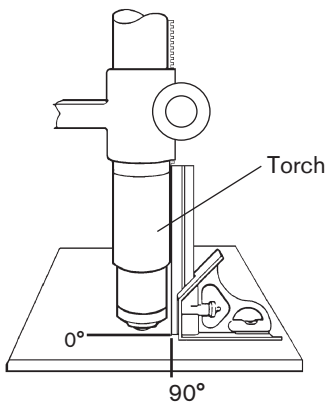

Connecting the torch lead

The Powermax105 is equipped with FastConnect™, a quick-disconnect system for connecting and disconnecting handheld and machine torch leads. When connecting or disconnecting a torch, first turn OFF the system. To connect the torch, push the connector into the receptacle on the front of the power supply.

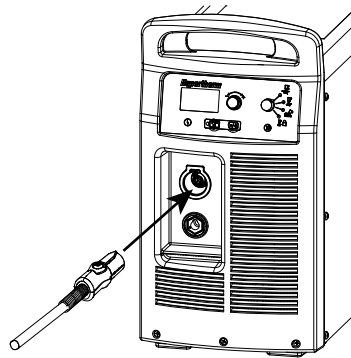

To remove the torch, press the red button on the connector and pull the connector out of the receptacle.

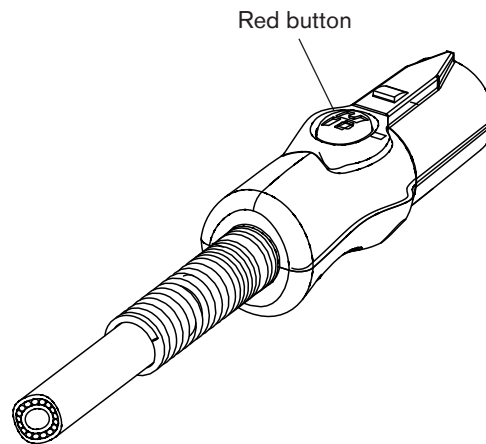

Using the cut charts

The following sections provide cut charts for each set of mechanized consumables. A consumable diagram with part numbers precedes each set of charts. For each consumable type, there are Metric and English charts for mild steel, stainless steel, and aluminum.

Each chart contains the following information:

- Amperage setting — Except for FineCut charts, the amperage setting at the top left side of the page applies to all the settings given on that page. In FineCut charts, the amperage setting for each thickness, either 45 or 40 (45, 40, or 30 for low speed), is included in the chart.
- Material Thickness — Thickness of the workpiece (metal plate being cut).
- Torch-to-Work Distance — For shielded consumables, the distance between the shield and the workpiece during cutting. For unshielded consumables, the distance between the nozzle and the workpiece during cutting.
- Initial Pierce Height — Distance between the shield (shielded) or the nozzle (unshielded) and the workpiece when the torch is triggered, prior to descending to the cut height.
- Pierce Delay Time — Length of time the triggered torch remains stationary at the pierce height before the torch starts the cutting motion.
- Best Quality Settings (cut speed and voltage) — Settings that provide the starting point for finding the best cut quality (best angle, least dross, best cut-surface finish). Adjust the speed for your application and table to obtain the desired result.
- Production Settings (cut speed and voltage) — 70% to 80% of the maximum speed ratings. These speeds result in the greatest number of cut parts, but not necessarily the best possible cut quality.

Note: The arc voltage increases as the consumables wear and the voltage setting should be increased to maintain the correct Torch-to-Work Distance.

Each cut chart lists hot and cold air flow rates.

- Hot air flow rate — Plasma is on, the system is operating at running current, and the system is in a steady state at the default system pressure (automatic mode).
- Cold air flow rate — Plasma is off and the system is in a steady state with air flowing through the torch at the default system pressure.

Note: Hypertherm collected the data under laboratory test conditions using new consumables.

Estimated kerf-width compensation

The widths in the tables below are for reference. The data are obtained with the “Best Quality” settings. Differences between installations and material composition may cause actual results to vary from those shown in the tables.

Estimated kerf-width compensation - Metric (mm)

Process	Thickness (mm)										
	0.5	1	2	3	6	8	10	12	16	20	25
Mild Steel											
105 A Shielded					2.1	2.2	2.2	2.2	2.5	2.7	3.3
85 A Shielded				1.7	1.8	1.9	2.0	2.2	2.4	2.6	
65 A Shielded			1.6	1.6	1.8	1.9	2.0	2.2	2.3		
45 A Shielded	1.1	1.1	1.4	1.5	1.7						
FineCut	0.9	0.7	0.5	0.6							
Low Speed FineCut	0.6	0.7	0.7	0.6							
105 A Unshielded					2.1	2.3	2.5	2.4	2.7	2.9	3.2
85 A Unshielded			1.7	1.8	1.9	2.0	2.1	2.1	2.3		
65 A Unshielded			1.6	1.6	1.7	1.8	1.9	2.0			
45 A Unshielded	0.5	0.9	1.3	1.3							
Stainless Steel											
105 A Shielded					1.9	2.1	2.3	2.3	2.3	2.6	2.9
85 A Shielded				1.6	1.8	1.9	2.1	2.3	2.4	2.5	
65 A Shielded			1.4	1.5	1.8	1.9	2.0	2.2	2.4		
45 A Shielded	0.9	1.1	1.5	1.6	1.8						
FineCut	0.2	0.5	0.4	0.5							
Low Speed FineCut	0.6	0.5	0.6	0.5							
105 A Unshielded					2.0	2.2	2.4	2.5	2.7	2.7	3.1
85 A Unshielded			1.7	1.7	1.8	1.9	2.1	2.2	2.4		
65 A Unshielded			1.6	1.6	1.8	1.8	1.9	2.0			
45 A Unshielded	0.5	1.0	1.3	1.5	1.5						
Aluminum											
105 A Shielded					2.3	2.3	2.4	2.6	2.7	3.0	3.5
85 A Shielded				2.0	1.9	2.0	2.1	2.2	2.4	2.6	
65 A Shielded			1.9	1.9	1.9	2.0	2.1	2.3	2.5		
45 A Shielded		1.5	1.5	1.6	1.5						
105 A Unshielded					2.2	2.4	2.5	2.6	2.7	3.0	3.3
85 A Unshielded			1.9	1.9	1.9	2.0	2.0	2.1	2.2		
65 A Unshielded			1.8	1.8	1.8	1.8	1.9	2.0			
45 A Unshielded		1.6	1.5	1.4	1.5						

MACHINE TORCH SETUP

Estimated kerf-width compensation - English (inches)

Process	Thickness (inches)										
	22GA	18GA	14GA	10GA	3/16	1/4	3/8	1/2	5/8	3/4	1
	Mild Steel										
105 A Shielded						0.083	0.088	0.089	0.100	0.101	0.133
85 A Shielded				0.068	0.071	0.073	0.078	0.090	0.095	0.100	
65 A Shielded			0.062	0.065	0.068	0.070	0.076	0.088	0.090	0.091	
45 A Shielded	0.035	0.054	0.055	0.061	0.065	0.066					
FineCut	0.028	0.026	0.016	0.023							
Low Speed FineCut	0.026	0.030	0.027	0.023							
105 A Unshielded						0.083	0.097	0.098	0.107	0.111	0.125
85 A Unshielded				0.070	0.073	0.075	0.080	0.085	0.090		
65 A Unshielded			0.062	0.064	0.066	0.068	0.075	0.081			
45 A Unshielded	0.020	0.050	0.051	0.054	0.057	0.059					
Stainless Steel											
105 A Shielded						0.076	0.089	0.091	0.092	0.099	0.113
85 A Shielded				0.065	0.068	0.070	0.080	0.094	0.095	0.096	
65 A Shielded			0.056	0.062	0.068	0.073	0.076	0.090	0.093		
45 A Shielded	0.032	0.055	0.058	0.067	0.069	0.069					
FineCut	0.025	0.019	0.014	0.027							
Low Speed FineCut	0.025	0.023	0.021	0.027							
105 A Unshielded						0.080	0.095	0.101	0.106	0.104	0.122
85 A Unshielded			0.066	0.068	0.070	0.072	0.080	0.090	0.095		
65 A Unshielded			0.061	0.064	0.067	0.070	0.072	0.080			
45 A Unshielded	0.020	0.054	0.052	0.060	0.058	0.058					
Aluminum											
		1/32	1/16	1/8	3/16	1/4	3/8	1/2	5/8	3/4	1
105 A Shielded						0.091	0.092	0.102	0.107	0.111	0.138
85 A Shielded				0.080	0.078	0.075	0.080	0.090	0.095	0.100	
65 A Shielded			0.073	0.074	0.075	0.076	0.083	0.091	0.100		
45 A Shielded		0.059	0.061	0.065		0.060					
105 A Unshielded						0.089	0.098	0.102	0.106	0.117	0.132
85 A Unshielded				0.075	0.075	0.075	0.080	0.082	0.088		
65 A Unshielded			0.070	0.070	0.070	0.070	0.072	0.079			
45 A Unshielded		0.062	0.058	0.057		0.061					

105 A Shielded consumables

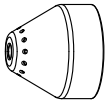

220993
Shield

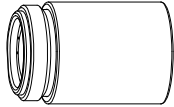

220854
Retaining cap



220990
Nozzle

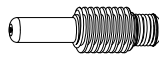

220842
Electrode

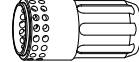

220994
Swirl ring

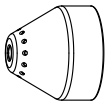
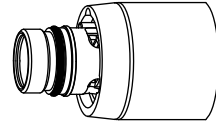

220993
Shield

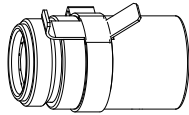

220953
Ohmic-sensing
retaining cap



220990
Nozzle

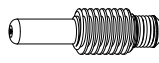

220842
Electrode

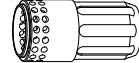

220994
Swirl ring

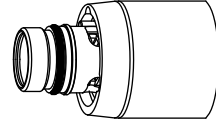

MACHINE TORCH SETUP

105 A Shielded cutting (Mild Steel)

Air flow rate - slpm/scfh	
Hot	217 / 460
Cold	250 / 530

Metric

Material Thickness	Torch-to-Work Distance	Initial Pierce Height		Pierce Delay Time	Best Quality Settings		Production Settings	
					Cut Speed	Voltage	Cut Speed	Voltage
mm	mm	mm	%	seconds	(mm/min)	Volts	(mm/min)	Volts
6	3.2	6.4	200	0.5	4140	144	5090	145
8				0.75	3140	145	3870	145
10					2260	145	2790	145
12					1690	145	2060	148
16				1.0	1060	149	1310	149
20		780	152		940	152		
25		Edge Start			550	159	580	158
30					370	162	410	161
32					350	166	370	161
35					290	168	320	165
40	190				173	210	170	

English

Material Thickness	Torch-to-Work Distance	Initial Pierce Height		Pierce Delay Time	Best Quality Settings		Production Settings	
					Cut Speed	Voltage	Cut Speed	Voltage
inches	inches	inches	%	seconds	ipm	Volts	ipm	Volts
1/4	0.125	0.25	200	0.5	156	144	192	145
3/8				0.75	94	145	116	145
1/2					62	146	76	148
5/8					1.0	42	149	52
3/4				33		151	40	150
7/8		1.25	26	154	30	157		
1			Edge Start			21	160	22
1-1/8		15				162	17	160
1-1/4		14				166	15	161
1-1/2		9				171	10	168

105 A Shielded cutting (Stainless Steel)

Air flow rate - slpm/scfh	
Hot	217 / 460
Cold	250 / 530

Metric

Material Thickness	Torch-to-Work Distance	Initial Pierce Height		Pierce Delay Time	Best Quality Settings		Production Settings	
					Cut Speed	Voltage	Cut Speed	Voltage
mm	mm	mm	%	seconds	(mm/min)	Volts	(mm/min)	Volts
6	3.2	6.4	200	0.5	4870	139	6000	141
8					3460	141	4210	142
10					2240	144	2670	142
12				1490	148	1860	144	
16		0.75	950	149	1080	149		
20		8.0	250	1.25	660	154	810	152
25		Edge Start			440	158	530	156
30					340	164	360	160
32	300				166	320	163	

English

Material Thickness	Torch-to-Work Distance	Initial Pierce Height		Pierce Delay Time	Best Quality Settings		Production Settings	
					Cut Speed	Voltage	Cut Speed	Voltage
inches	inches	inches	%	seconds	ipm	Volts	ipm	Volts
1/4	0.125	0.25	200	0.5	185	139	224	141
3/8					94	143	112	142
1/2					55	148	68	145
5/8				38	149	43	149	
3/4		0.31	250	1.25	28	153	34	151
7/8		Edge Start			22	156	27	153
1					17	158	20	156
1-1/8					14	162	16	159
1-1/4	12				166	13	163	

MACHINE TORCH SETUP

105 A Shielded cutting (Aluminum)

Air flow rate - slpm/scfh	
Hot	217 / 460
Cold	250 / 530

Metric

Material Thickness	Torch-to-Work Distance	Initial Pierce Height		Pierce Delay Time	Best Quality Settings		Production Settings	
					Cut Speed	Voltage	Cut Speed	Voltage
mm	mm	mm	%	seconds	(mm/min)	Volts	(mm/min)	Volts
6	3.2	6.4	200	0.5	5980	145	7090	144
8				0.75	4170	149	5020	148
10					2640	152	3280	151
12				1.0	1910	156	2450	154
16					1290	157	1660	155
20		1.25	1020	163	1190	162		
25		Edge Start			660	166	790	165
30					430	173	570	171
32	340				175	490	173	

English

Material Thickness	Torch-to-Work Distance	Initial Pierce Height		Pierce Delay Time	Best Quality Settings		Production Settings	
					Cut Speed	Voltage	Cut Speed	Voltage
inches	inches	inches	%	seconds	ipm	Volts	ipm	Volts
1/4	0.125	0.25	200	0.5	223	146	265	145
3/8				0.75	110	151	136	150
1/2					1.0	71	156	91
5/8				51		157	66	155
3/4				1.25	43	162	50	161
7/8		Edge Start			34	164	40	163
1					25	166	30	165
1-1/8					20	171	25	169
1-1/4	15				175	20	173	

85 A Shielded consumables

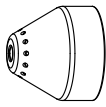

220817
Shield

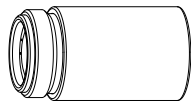

220854
Retaining cap



220816
Nozzle

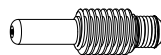

220842
Electrode

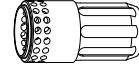

220994
Swirl ring

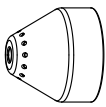
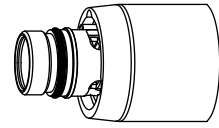

220817
Shield

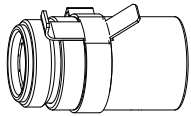

220953
Ohmic-sensing
retaining cap



220816
Nozzle

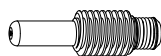

220842
Electrode

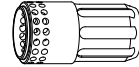

220994
Swirl ring

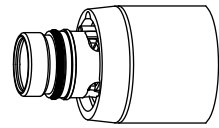

MACHINE TORCH SETUP

85 A Shielded cutting (Mild Steel)

Air flow rate - slpm/scfh	
Hot	194 / 412
Cold	236 / 500

Metric

Material Thickness	Torch-to-Work Distance	Initial Pierce Height		Pierce Delay Time	Best Quality Settings		Production Settings	
					Cut Speed	Voltage	Cut Speed	Voltage
mm	mm	mm	%	seconds	(mm/min)	Volts	(mm/min)	Volts
3	1.5	3.8	250	0.1	6800	122	9200	120
4				0.2	5650	122	7300	122
6				0.5	3600	123	4400	125
8					2500	125	3100	127
10		4.5	300	0.7	1280	130	1600	130
12				1.0	870	134	930	133
16		6.0	400	1.5	570	137	680	136
20				Edge Start		350	142	450
25		Edge Start		200	146	300	144	
30		Edge Start						

English

Material Thickness	Torch-to-Work Distance	Initial Pierce Height		Pierce Delay Time	Best Quality Settings		Production Settings	
					Cut Speed	Voltage	Cut Speed	Voltage
inches	inches	inches	%	seconds	ipm	Volts	ipm	Volts
10GA	0.06	0.15	250	0.0	250	122	336	121
3/16				0.2	185	123	220	123
1/4				0.5	130	123	160	126
3/8					70	126	86	127
1/2		0.18	300	45	131	56	131	
5/8				1.0	35	134	37	133
3/4		0.24	400	1.5	24	136	29	135
7/8				Edge Start		19	139	22
1		Edge Start		13	142	17	141	
1-1/8		Edge Start		9	145	13	143	
1-1/4	Edge Start		7	148	10	146		

85 A Shielded cutting (Stainless Steel)

Air flow rate - slpm/scfh	
Hot	194 / 412
Cold	236 / 500

Metric

Material Thickness	Torch-to-Work Distance	Initial Pierce Height		Pierce Delay Time	Best Quality Settings		Production Settings	
					Cut Speed	Voltage	Cut Speed	Voltage
mm	mm	mm	%	seconds	(mm/min)	Volts	(mm/min)	Volts
3	1.5	3.8	250	0.1	7500	122	9200	120
4				0.2	6100	122	7500	120
6				0.5	3700	122	4600	122
8					2450	124	3050	124
10		4.5	300	1550	127	1900	126	
12				1100	131	1400	130	
16				700	135	760	134	
20				Edge Start		480	138	570
25		Edge Start		300	143	370	141	

English

Material Thickness	Torch-to-Work Distance	Initial Pierce Height		Pierce Delay Time	Best Quality Settings		Production Settings	
					Cut Speed	Voltage	Cut Speed	Voltage
inches	inches	inches	%	seconds	ipm	Volts	ipm	Volts
10GA	0.06	0.15	250	0.2	275	122	336	120
3/16					200	122	240	121
1/4				0.5	130	122	164	122
3/8					65	126	80	125
1/2		0.18	300	1.0	36	132	48	131
5/8					28	135	30	134
3/4				Edge Start		20	137	24
7/8		Edge Start		16	140	19	139	
1		Edge Start		11	143	14	141	

MACHINE TORCH SETUP

85 A Shielded cutting (Aluminum)

Air flow rate - slpm/scfh	
Hot	194 / 412
Cold	236 / 500

Metric

Material Thickness	Torch-to-Work Distance	Initial Pierce Height		Pierce Delay Time	Best Quality Settings		Production Settings	
					Cut Speed	Voltage	Cut Speed	Voltage
mm	mm	mm	%	seconds	(mm/min)	Volts	(mm/min)	Volts
3	1.5	3.8	250	0.1	8000	122	9400	121
4				0.2	6500	123	8000	123
6				0.5	3800	126	4900	126
8					2650	130	3470	129
10		4.5	300	1920	132	2500	131	
12				1450	134	1930	133	
16				950	139	1200	137	
20				Edge Start		600	143	880
25		Edge Start		380	146	540	144	

English

Material Thickness	Torch-to-Work Distance	Initial Pierce Height		Pierce Delay Time	Best Quality Settings		Production Settings		
					Cut Speed	Voltage	Cut Speed	Voltage	
inches	inches	inches	%	seconds	ipm	Volts	ipm	Volts	
1/8	0.06	0.15	250	0.2	300	122	360	121	
1/4				0.5	130	127	172	127	
3/8					80	132	104	131	
1/2				0.18	300	50	135	68	133
5/8		38	139			48	137		
3/4		Edge Start				25	142	37	140
7/8		Edge Start				20	144	29	142
1		Edge Start		14	146	20	144		

65 A Shielded consumables

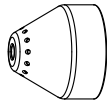

220817
Shield

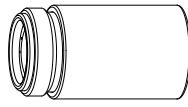

220854
Retaining cap



220819
Nozzle

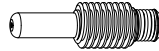

220842
Electrode

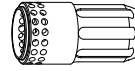

220994
Swirl ring

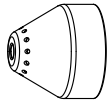
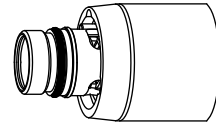

220817
Shield

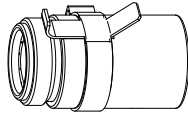

220953
Ohmic-sensing
retaining cap



220819
Nozzle

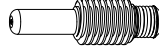

220842
Electrode

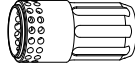

220994
Swirl ring

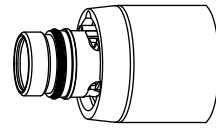

MACHINE TORCH SETUP

65 A Shielded cutting (Mild Steel)

Air flow rate - slpm/scfh	
Hot	175 / 370
Cold	209 / 443

Metric

Material Thickness	Torch-to-Work Distance	Initial Pierce Height		Pierce Delay Time	Best Quality Settings		Production Settings		
					Cut Speed	Voltage	Cut Speed	Voltage	
mm	mm	mm	%	seconds	(mm/min)	Volts	(mm/min)	Volts	
2	1.5	3.8	250	0.1	6050	124	7000	121	
3				0.2	5200	125	6100	123	
4				0.5	4250	125	5100	124	
6					2550	127	3240	127	
8					1700	129	2230	128	
10		4.5	300	0.7	1100	131	1500	129	
12				1.2	850	134	1140	131	
16		6.0	400	2.0	560	138	650	136	
20		Edge Start				350	142	450	142
25		Edge Start				210	145	270	145

English

Material Thickness	Torch-to-Work Distance	Initial Pierce Height		Pierce Delay Time	Best Quality Settings		Production Settings		
					Cut Speed	Voltage	Cut Speed	Voltage	
inches	inches	inches	%	seconds	ipm	Volts	ipm	Volts	
16GA	0.06	0.15	250	0.1	260	123	294	121	
10GA					190	125	224	123	
3/16				0.2	140	126	168	125	
1/4					0.5	90	127	116	127
3/8						45	130	62	129
1/2		0.18	300	1.2	30	135	40	132	
5/8		0.24	400	2.0	23	138	26	136	
3/4		Edge Start				15	141	19	141
7/8		Edge Start				12	143	14	143
1		Edge Start				8	145	10	145

65 A Shielded cutting (Stainless Steel)

Air flow rate - slpm/scfh	
Hot	175 / 370
Cold	209 / 443

Metric

Material Thickness	Torch-to-Work Distance	Initial Pierce Height		Pierce Delay Time	Best Quality Settings		Production Settings	
					Cut Speed	Voltage	Cut Speed	Voltage
mm	mm	mm	%	seconds	(mm/min)	Volts	(mm/min)	Volts
2	1.5	3.8	250	0.1	8100	125	10000	121
3				0.2	6700	125	8260	123
4				0.5	5200	125	6150	124
6					2450	126	2850	126
8				0.7	1500	129	1860	129
10		4.5	300		960	132	1250	132
12					750	135	920	134
16		Edge Start			500	139	500	139
20		Edge Start			300	143	370	143

English

Material Thickness	Torch-to-Work Distance	Initial Pierce Height		Pierce Delay Time	Best Quality Settings		Production Settings	
					Cut Speed	Voltage	Cut Speed	Voltage
inches	inches	inches	%	seconds	ipm	Volts	ipm	Volts
16GA	0.06	0.15	250	0.1	345	124	426	121
10GA					240	125	296	123
3/16				0.2	155	126	168	125
1/4					80	126	96	126
3/8				0.7	40	131	52	131
1/2		0.18	300		1.2	26	136	32
5/8		Edge Start			20	139	20	139
3/4		Edge Start			14	142	15	142

MACHINE TORCH SETUP

65 A Shielded cutting (Aluminum)

Air flow rate - slpm/scfh	
Hot	175 / 370
Cold	209 / 443

Metric

Material Thickness	Torch-to-Work Distance	Initial Pierce Height		Pierce Delay Time	Best Quality Settings		Production Settings			
					Cut Speed	Voltage	Cut Speed	Voltage		
mm	mm	mm	%	seconds	(mm/min)	Volts	(mm/min)	Volts		
2	1.5	3.8	250	0.1	8800	121	10300	122		
3				0.2	7400	124	8800	124		
4				0.5	6000	126	7350	125		
6					3200	130	4400	128		
8				0.7	1950	133	2750	130		
10		1200	136		1650	132				
12		1000	138		1330	136				
16		4.5	300	1.2	Edge Start		650	143	800	141
20					380	147	560	145		

English

Material Thickness	Torch-to-Work Distance	Initial Pierce Height		Pierce Delay Time	Best Quality Settings		Production Settings	
					Cut Speed	Voltage	Cut Speed	Voltage
inches	inches	inches	%	seconds	ipm	Volts	ipm	Volts
1/16	0.06	0.15	250	0.1	365	121	428	121
1/8					280	124	336	124
1/4				0.5	105	131	152	128
3/8					50	135	68	131
1/2		0.18	300	1.2	35	139	48	138
5/8					Edge Start		26	143
3/4		Edge Start		16	146	24	144	

45 A Shielded consumables

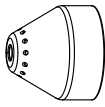

220817
Shield

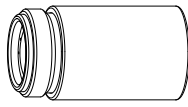

220854
Retaining cap



220941
Nozzle

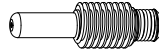

220842
Electrode

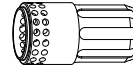

220994
Swirl ring

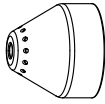
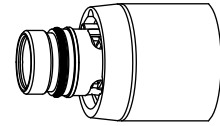

220817
Shield

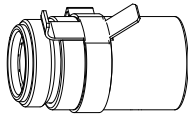

220953
Ohmic-sensing
retaining cap



220941
Nozzle

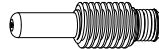

220842
Electrode

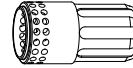

220994
Swirl ring

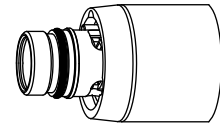

MACHINE TORCH SETUP

45 A Shielded cutting (Mild Steel)

Air flow rate - slpm/scfh	
Hot	177 / 376
Cold	201 / 427

Metric

Material Thickness	Torch-to-Work Distance	Initial Pierce Height		Pierce Delay Time	Best Quality Settings		Production Settings	
					Cut Speed	Voltage	Cut Speed	Voltage
mm	mm	mm	%	seconds	(mm/min)	Volts	(mm/min)	Volts
0.5	1.5	3.8	250	0.0	9000	128	12500	126
1					9000	128	10800	128
1.5				0.1	9000	130	10200	129
2				0.3	6600	130	7800	129
3					0.4	3850	133	4900
4				2200		134	3560	131
6				0.5	1350	137	2050	132

English

Material Thickness	Torch-to-Work Distance	Initial Pierce Height		Pierce Delay Time	Best Quality Settings		Production Settings	
					Cut Speed	Voltage	Cut Speed	Voltage
inches	inches	inches	%	seconds	ipm	Volts	ipm	Volts
26GA	0.02	0.08	400	0.0	350	128	500	128
22GA					350	128	450	128
18GA				0.1	350	129	400	128
16GA					350	130	400	129
14GA	0.06	0.15	250	0.2	270	130	320	129
12GA				0.4	190	133	216	131
					10GA	100	134	164
3/16				0.5	70	135	108	132
1/4				0.6	48	137	73	132

45 A Shielded cutting (Stainless Steel)

Air flow rate - slpm/scfh	
Hot	177 / 376
Cold	201 / 427

Metric

Material Thickness	Torch-to-Work Distance	Initial Pierce Height		Pierce Delay Time	Best Quality Settings		Production Settings	
					Cut Speed	Voltage	Cut Speed	Voltage
mm	mm	mm	%	seconds	(mm/min)	Volts	(mm/min)	Volts
0.5	1.5	3.8	250	0.0	9000	130	12500	129
1					9000	130	10800	130
1.5				0.1	9000	130	10200	130
2					6000	132	8660	131
3				0.4	3100	132	4400	132
4					2000	134	2600	134
6				0.5	900	140	1020	139

English

Material Thickness	Torch-to-Work Distance	Initial Pierce Height		Pierce Delay Time	Best Quality Settings		Production Settings	
					Cut Speed	Voltage	Cut Speed	Voltage
inches	inches	inches	%	seconds	ipm	Volts	ipm	Volts
26GA	0.02	0.08	400	0.0	350	130	500	129
22GA					350	130	450	129
18GA				0.1	350	130	400	130
16GA					350	130	400	130
14GA	0.06	0.15	250	0.2	250	132	360	131
12GA				0.4	140	132	206	131
10GA					100	133	134	134
3/16				0.5	52	135	58	135
1/4				0.6	30	141	35	140

MACHINE TORCH SETUP

45 A Shielded cutting (Aluminum)

Air flow rate - slpm/scfh	
Hot	177 / 376
Cold	201 / 427

Metric

Material Thickness	Torch-to-Work Distance	Initial Pierce Height		Pierce Delay Time	Best Quality Settings		Production Settings	
					Cut Speed	Voltage	Cut Speed	Voltage
mm	mm	mm	%	seconds	(mm/min)	Volts	(mm/min)	Volts
1	1.5	3.8	250	0.0	8250	136	11000	136
2				0.1	6600	136	9200	135
3				0.2	3100	139	6250	134
4				0.4	2200	141	4850	135
6				0.5	1500	142	2800	137

English

Material Thickness	Torch-to-Work Distance	Initial Pierce Height		Pierce Delay Time	Best Quality Settings		Production Settings	
					Cut Speed	Voltage	Cut Speed	Voltage
inches	inches	inches	%	seconds	ipm	Volts	ipm	Volts
1/32	0.06	0.15	250	0.0	325	136	450	136
1/16				0.1	325	136	400	136
3/32				0.2	200	136	328	134
1/8				0.4	100	140	224	134
1/4				0.5	54	142	96	137

FineCut® consumables

Note: The cut charts in this section apply to both shielded and unshielded consumables.

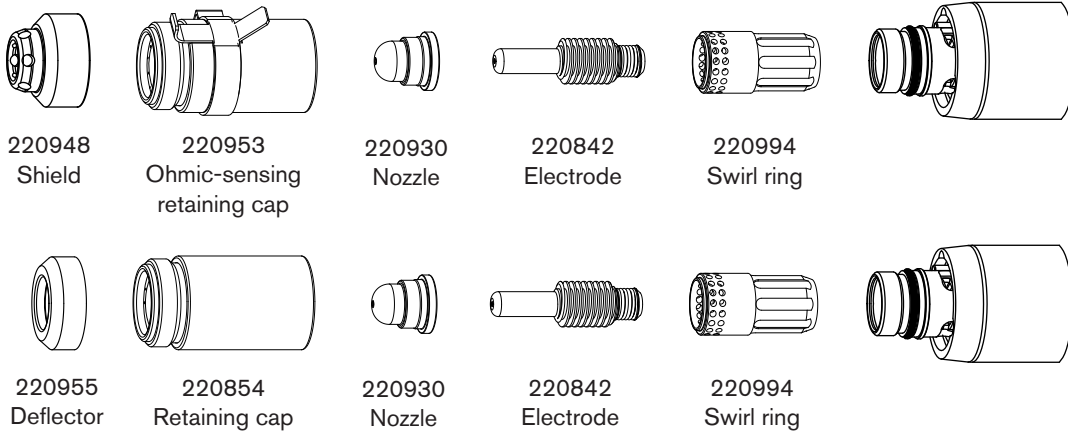

MACHINE TORCH SETUP

FineCut (Mild Steel)

Air flow rate - slpm/scfh	
Hot	181 / 384
Cold	191 / 404

Metric

Material Thickness	Current	Torch-to-Work Distance	Initial Pierce Height		Pierce Delay Time	Recommended		
						Cut Speed	Voltage	
mm	A	mm	mm	%	seconds	(mm/min)	Volts	
0.5	40	1.5	2.25	150	0.0	8250	78	
0.6						8250	78	
0.8						8250	78	
1	45				0.2	8250	78	
1.5						0.4	6400	78
2							4800	78
3						0.5	2750	78
4						0.6	1900	78

English

Material Thickness	Current	Torch-to-Work Distance	Initial Pierce Height		Pierce Delay Time	Recommended		
						Cut Speed	Voltage	
	A	inches	inches	%	seconds	ipm	Volts	
26GA	40	0.06	0.09	150	0.0	325	78	
24GA						325	78	
22GA					0.1	325	78	
20GA						325	78	
18GA	45				0.2	325	78	
16GA						0.4	250	78
14GA							200	78
12GA						0.5	120	78
10GA		95	78					

FineCut (Stainless Steel)

Air flow rate - slpm/scfh	
Hot	181 / 384
Cold	191 / 404

Metric

Material Thickness	Current	Torch-to-Work Distance	Initial Pierce Height		Pierce Delay Time	Recommended		
						Cut Speed	Voltage	
mm	A	mm	mm	%	seconds	(mm/min)	Volts	
0.5	40	0.5	2.0	400	0.0	8250	68	
0.6						8250	68	
0.8						8250	68	
1	45				0.15	8250	68	
1.5						0.4	6150	70
2							4800	71
3						0.5	2550	80
4						0.6	1050	80

English

Material Thickness	Current	Torch-to-Work Distance	Initial Pierce Height		Pierce Delay Time	Recommended		
						Cut Speed	Voltage	
	A	inches	inches	%	seconds	ipm	Volts	
26GA	40	0.02	0.08	400	0.0	325	68	
24GA						325	68	
22GA					0.1	325	68	
20GA						325	68	
18GA	45				0.2	325	68	
16GA						0.4	240	70
14GA							200	70
12GA						0.5	120	80
10GA		0.6	75	80				

MACHINE TORCH SETUP

Low Speed FineCut (Mild Steel)

Air flow rate - slpm/scfh	
Hot	181 / 384
Cold	191 / 404

Metric

Material Thickness	Current	Torch-to-Work Distance	Initial Pierce Height		Pierce Delay Time	Recommended			
						Cut Speed	Voltage		
mm	A	mm	mm	%	seconds	(mm/min)	Volts		
0.5	30	1.5	2.25	150	0.0	3800	69		
0.6						3800	68		
0.8					3800	70			
1 *	40						0.2	3800	72
1.5 *							0.4	3800	75
2	45				3700	76			
3					0.5	2750	78		
4					1900	78			

English

Material Thickness	Current	Torch-to-Work Distance	Initial Pierce Height		Pierce Delay Time	Recommended		
						Cut Speed	Voltage	
	A	inches	inches	%	seconds	ipm	Volts	
26GA	30	0.06	0.09	150	0.0	150	70	
24GA						150	68	
22GA					150	70		
20GA	0.1						150	71
18GA							150	73
16GA *	40				0.4	150	75	
14GA *						45	0.5	150
12GA	120				78			
10GA	95	78						

*Not a dross-free cut.

Low Speed FineCut (Stainless Steel)

Air flow rate - slpm/scfh	
Hot	181 / 384
Cold	191 / 404

Metric

Material Thickness	Current	Torch-to-Work Distance	Initial Pierce Height		Pierce Delay Time	Recommended		
						Cut Speed	Voltage	
mm	A	mm	mm	%	seconds	(mm/min)	Volts	
0.5	30	0.5	2.0	400	0.0	3800	69	
0.6						3800	69	
0.8						3800	69	
1	40				0.15	3800	69	
1.5						0.4	2900	69
2							2750	69
3	45				0.5	2550	80	
4						0.6	1050	80

English

Material Thickness	Current	Torch-to-Work Distance	Initial Pierce Height		Pierce Delay Time	Recommended		
						Cut Speed	Voltage	
	A	in	in	%	seconds	ipm	Volts	
26GA	30	0.02	0.08	400	0.0	150	69	
24GA						150	69	
22GA					0.1	150	69	
20GA						150	69	
18GA	40				0.2	145	69	
16GA						0.4	115	69
14GA							110	69
12GA	45				0.5	120	80	
10GA		0.6	75	80				

105 A Unshielded consumables

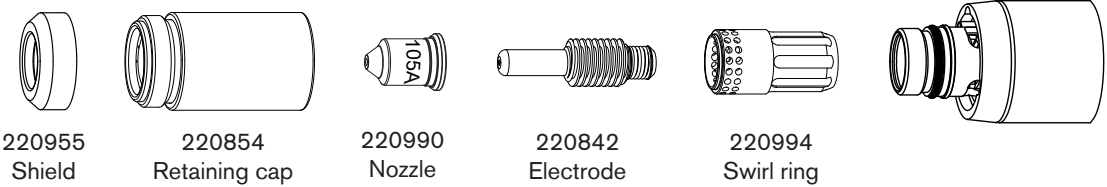

105 A Unshielded cutting (Mild Steel)

Air flow rate - slpm/scfh	
Hot	217 / 460
Cold	250 / 530

Metric

Material Thickness	Torch-to-Work Distance	Initial Pierce Height		Pierce Delay Time	Best Quality Settings		Production Settings	
					Cut Speed	Voltage	Cut Speed	Voltage
mm	mm	mm	%	seconds	(mm/min)	Volts	(mm/min)	Volts
6	4.6	9.2	200	0.5	4040	148	4980	145
8					3160	149	3770	145
10					2350	150	2700	145
12				1700	153	2080	147	
16				0.6	980	155	1200	152
20				1.0	742	155	940	154
25		Edge Start			500	159	580	159
30					300	161	370	160
32					260	169	270	167
35					320	164	350	163
40					160	176	190	172

English

Material Thickness	Torch-to-Work Distance	Initial Pierce Height		Pierce Delay Time	Best Quality Settings		Production Settings	
					Cut Speed	Voltage	Cut Speed	Voltage
inches	inches	inches	%	seconds	ipm	Volts	ipm	Volts
1/4	0.18	0.36	200	0.5	153	148	188	145
3/8					91	150	112	145
1/2					62	153	76	148
5/8				0.6	39	155	48	152
3/4				1.0	31	155	40	153
7/8				1.25	25	156	30	158
1		Edge Start			19	160	22	159
1-1/8					14	161	17	160
1-1/4					13	164	14	163

MACHINE TORCH SETUP

105 A Unshielded cutting (Stainless Steel)

Air flow rate - slpm/scfh	
Hot	217 / 460
Cold	250 / 530

Metric

Material Thickness	Torch-to-Work Distance	Initial Pierce Height		Pierce Delay Time	Best Quality Settings		Production Settings	
					Cut Speed	Voltage	Cut Speed	Voltage
mm	mm	mm	%	seconds	(mm/min)	Volts	(mm/min)	Volts
6	4.6	9.2	200	0.5	4970	145	6120	142
8					3420	147	4210	144
10					2090	149	2570	146
12					1410	151	1740	149
16				0.75	880	153	1080	151
20				1.0	660	156	800	155
25		Edge Start			420	159	500	159
30		Edge Start			330	162	370	161
32		Edge Start			300	163	320	162

English

Material Thickness	Torch-to-Work Distance	Initial Pierce Height		Pierce Delay Time	Best Quality Settings		Production Settings	
					Cut Speed	Voltage	Cut Speed	Voltage
inches	inches	inches	%	seconds	ipm	Volts	ipm	Volts
1/4	0.18	0.36	200	0.5	185	145	228	142
3/8					88	149	108	145
1/2					52	151	64	149
5/8					0.75	35	153	43
3/4				1.0	28	155	34	154
7/8				Edge Start			22	157
1		Edge Start			16	159	19	159
1-1/8		Edge Start			14	161	16	161

105 A Unshielded cutting (Aluminum)

Air flow rate - slpm/scfh	
Hot	217 / 460
Cold	250 / 530

Metric

Material Thickness	Torch-to-Work Distance	Initial Pierce Height		Pierce Delay Time	Best Quality Settings		Production Settings	
					Cut Speed	Voltage	Cut Speed	Voltage
mm	mm	mm	%	seconds	(mm/min)	Volts	(mm/min)	Volts
6	4.6	9.2	200	0.5	5840	148	7170	149
8				0.75	4110	152	5060	151
10					2670	154	3580	153
12				1.0	2090	155	2450	154
16		1330	160		1660	158		
20		Edge Start			980	163	1190	162
25					660	167	770	167
30					500	170	590	169
32					450	171	520	170

English

Material Thickness	Torch-to-Work Distance	Initial Pierce Height		Pierce Delay Time	Best Quality Settings		Production Settings		
					Cut Speed	Voltage	Cut Speed	Voltage	
inches	inches	inches	%	seconds	ipm	Volts	ipm	Volts	
1/4	0.180	0.36	200	0.5	218	149	268	149	
3/8				0.75	110	154	136	153	
1/2					1.0	77	156	91	155
5/8				51		160	66	158	
3/4		1.25	41	162	50	161			
7/8			Edge Start			33	165	40	164
1						25	167	29	167
1-1/8						20	169	25	169

85 A Unshielded consumables

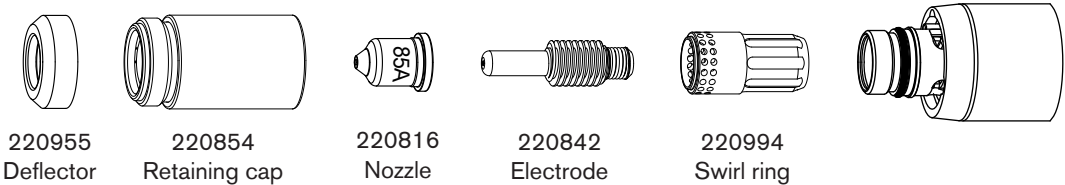

85 A Unshielded cutting (Mild Steel)

Air flow rate - slpm/scfh	
Hot	194 / 412
Cold	236 / 500

Metric

Material Thickness	Torch-to-Work Distance	Initial Pierce Height		Pierce Delay Time	Best Quality Settings		Production Settings	
					Cut Speed	Voltage	Cut Speed	Voltage
mm	mm	mm	%	seconds	(mm/min)	Volts	(mm/min)	Volts
2	2.0	5.0	250	0.0	7150	117	10400	116
3				0.1	6240	118	9000	117
4				0.2	5250	118	7200	117
6				0.5	3450	120	4400	119
8					2400	121	3100	121
10		1560	123	2070	122			
12		6.0	300	0.7	1200	126	1600	124
16		Edge Start			820	132	930	128
20					540	137	640	132
25					320	143	400	137

English

Material Thickness	Torch-to-Work Distance	Initial Pierce Height		Pierce Delay Time	Best Quality Settings		Production Settings	
					Cut Speed	Voltage	Cut Speed	Voltage
inches	inches	inches	%	seconds	ipm	Volts	ipm	Volts
14GA	0.08	0.20	250	0.1	280	117	416	116
10GA				0.2	230	118	328	117
3/16					175	119	220	118
1/4				0.5	125	120	160	119
3/8					65	122	86	122
1/2		0.24	300	0.6	42	127	56	125
5/8		Edge Start			33	131	37	128
3/4					23	136	27	131
7/8					18	140	21	134
1					12	144	15	138

MACHINE TORCH SETUP

85 A Unshielded cutting (Stainless Steel)

Air flow rate - slpm/scfh	
Hot	194 / 412
Cold	236 / 500

Metric

Material Thickness	Torch-to-Work Distance	Initial Pierce Height		Pierce Delay Time	Best Quality Settings		Production Settings	
					Cut Speed	Voltage	Cut Speed	Voltage
mm	mm	mm	%	seconds	(mm/min)	Volts	(mm/min)	Volts
2	2.0	5.0	250	0.1	8550	117	11300	116
3					7000	118	9660	117
4				5600	118	7800	118	
6				3400	120	4570	121	
8		6.0	300	0.5	2250	121	2970	122
10					1430	123	1840	124
12		Edge Start			1000	129	1340	128
16					650	134	730	133
20					360	138	570	137

English

Material Thickness	Torch-to-Work Distance	Initial Pierce Height		Pierce Delay Time	Best Quality Settings		Production Settings	
					Cut Speed	Voltage	Cut Speed	Voltage
inches	inches	inches	%	seconds	ipm	Volts	ipm	Volts
14GA	0.08	0.20	250	0.1	340	117	452	116
10GA					250	118	352	118
3/16				180	119	249	119	
1/4				120	120	160	121	
3/8		0.24	300	0.5	60	122	77	123
1/2					35	131	46	129
5/8		Edge Start			26	134	29	133
3/4					17	137	24	136

85 A Unshielded cutting (Aluminum)

Air flow rate - slpm/scfh	
Hot	194 / 412
Cold	236 / 500

Metric

Material Thickness	Torch-to-Work Distance	Initial Pierce Height		Pierce Delay Time	Best Quality Settings		Production Settings		
					Cut Speed	Voltage	Cut Speed	Voltage	
mm	mm	mm	%	seconds	(mm/min)	Volts	(mm/min)	Volts	
2	2.0	5.0	250	0.1	8700	118	11200	118	
3					7350	120	9600	119	
4				6000	122	8100	120		
6				0.5	3300	125	4930	122	
8					2350	127	3250	124	
10				6.0	300	0.5	1800	128	2140
12		0.7	1300			133	1720	130	
16		Edge Start				840	139	1130	134
20						470	144	700	138

English

Material Thickness	Torch-to-Work Distance	Initial Pierce Height		Pierce Delay Time	Best Quality Settings		Production Settings		
					Cut Speed	Voltage	Cut Speed	Voltage	
inches	inches	inches	%	seconds	ipm	Volts	ipm	Volts	
1/8	0.08	0.20	250	0.2	280	120	368	119	
3/16					200	123	271	120	
1/4				0.5	110	126	172	122	
3/8					75	127	88	126	
1/2		0.24	300	0.6	45	135	62	131	
5/8				Edge Start			34	139	45
3/4						22	143	32	137

65 A Unshielded consumables

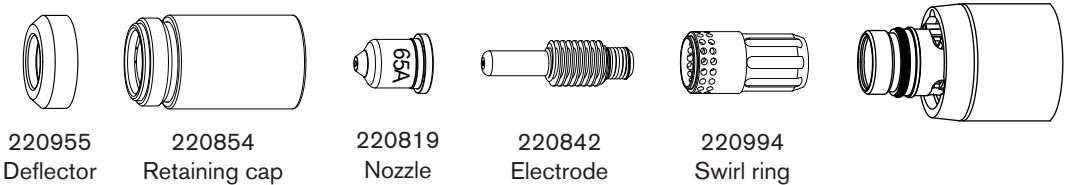

65 A Unshielded cutting (Mild Steel)

Air flow rate - slpm/scfh	
Hot	175 / 370
Cold	209 / 443

Metric

Material Thickness	Torch-to-Work Distance	Initial Pierce Height		Pierce Delay Time	Best Quality Settings		Production Settings	
					Cut Speed	Voltage	Cut Speed	Voltage
mm	mm	mm	%	seconds	(mm/min)	Volts	(mm/min)	Volts
2	2.0	5.0	250	0.1	6050	117	7340	117
3				0.2	5200	118	6330	118
4				0.5	4250	118	5250	118
6					2550	120	3560	120
8		1620	123	2230	121			
10		6.0	300	0.7	970	127	1500	122
12		Edge Start			760	129	1140	124
16					500	134	650	129
20					280	138	400	133

English

Material Thickness	Torch-to-Work Distance	Initial Pierce Height		Pierce Delay Time	Best Quality Settings		Production Settings	
					Cut Speed	Voltage	Cut Speed	Voltage
inches	inches	inches	%	seconds	ipm	Volts	ipm	Volts
16GA	0.08	0.20	250	0.1	255	116	308	117
10GA					190	118	232	118
3/16				0.2	135	119	172	119
1/4					90	120	116	120
3/8		0.24	300	0.7	40	126	62	122
1/2		Edge Start			27	130	40	125
5/8					20	134	26	129
3/4					13	137	18	132

MACHINE TORCH SETUP

65 A Unshielded cutting (Stainless Steel)

Air flow rate - slpm/scfh	
Hot	175 / 370
Cold	209 / 443

Metric

Material Thickness	Torch-to-Work Distance	Initial Pierce Height		Pierce Delay Time	Best Quality Settings		Production Settings			
					Cut Speed	Voltage	Cut Speed	Voltage		
mm	mm	mm	%	seconds	(mm/min)	Volts	(mm/min)	Volts		
2	2.0	5.0	250	0.1	7950	117	10300	116		
3				0.2	6600	118	8500	117		
4				0.5	5050	119	6500	119		
6					2300	121	3070	121		
8		6.0	300	0.7	1400	123	1900	122		
10					920	126	1250	123		
12					Edge Start		710	130	925	127
16					430	135	500	133		

English

Material Thickness	Torch-to-Work Distance	Initial Pierce Height		Pierce Delay Time	Best Quality Settings		Production Settings			
					Cut Speed	Voltage	Cut Speed	Voltage		
inches	inches	inches	%	seconds	ipm	Volts	ipm	Volts		
16GA	0.08	0.20	250	0.1	340	116	437	115		
10GA					235	118	304	118		
3/16					0.2	150	120	194	120	
1/4						75	121	100	121	
3/8		0.24	300	0.7	38	125	52	122		
1/2					Edge Start		25	132	32	129
5/8					17	135	20	133		

65 A Unshielded cutting (Aluminum)

Air flow rate - slpm/scfh	
Hot	175 / 370
Cold	209 / 443

Metric

Material Thickness	Torch-to-Work Distance	Initial Pierce Height		Pierce Delay Time	Best Quality Settings		Production Settings	
					Cut Speed	Voltage	Cut Speed	Voltage
mm	mm	mm	%	seconds	(mm/min)	Volts	(mm/min)	Volts
2	2.0	5.0	250	0.1	7750	123	11300	122
3				0.2	6550	124	9500	123
4				0.5	5400	125	7640	124
6					3000	127	3900	126
8				0.7	1800	130	2460	127
10		6.0	300	0.7	1100	133	1640	129
12		Edge Start			900	135	1250	133
16		Edge Start			600	139	700	136

English

Material Thickness	Torch-to-Work Distance	Initial Pierce Height		Pierce Delay Time	Best Quality Settings		Production Settings	
					Cut Speed	Voltage	Cut Speed	Voltage
inches	inches	inches	%	seconds	ipm	Volts	ipm	Volts
1/16	0.08	0.20	250	0.1	325	122	476	122
1/8					250	124	360	123
3/16					175	125	245	124
1/4					0.5	100	127	128
3/8				0.24		300	0.7	45
1/2		Edge Start			32	136	44	134
5/8		Edge Start			24	138	28	136

45 A Unshielded consumables

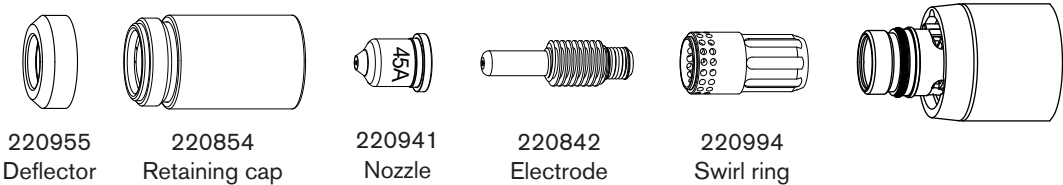

45 A Unshielded cutting (Mild Steel)

Air flow rate - slpm/scfh	
Hot	177 / 376
Cold	201 / 427

Metric

Material Thickness	Torch-to-Work Distance	Initial Pierce Height		Pierce Delay Time	Best Quality Settings		Production Settings	
					Cut Speed	Voltage	Cut Speed	Voltage
mm	mm	mm	%	seconds	(mm/min)	Volts	(mm/min)	Volts
0.5	1.5	3.8	250	0.0	9000	120	12500	120
1					9000	120	10800	121
1.5				7700	120	10200	121	
2				6150	119	7800	122	
3				0.4	3950	121	4900	123
4					2350	123	3560	124
6				0.5	1400	126	2050	124

English

Material Thickness	Torch-to-Work Distance	Initial Pierce Height		Pierce Delay Time	Best Quality Settings		Production Settings	
					Cut Speed	Voltage	Cut Speed	Voltage
inches	inches	inches	%	seconds	ipm	Volts	ipm	Volts
26GA	0.06	0.15	250	0.0	350	120	500	120
22GA					350	120	450	120
18GA				0.1	350	119	400	121
16GA					300	121	400	121
14GA				0.2	250	119	320	122
12GA				0.4	200	120	216	123
10GA					100	123	164	124
3/16				0.5	85	122	108	124
1/4				0.6	48	127	73	124

MACHINE TORCH SETUP

45 A Unshielded cutting (Stainless Steel)

Air flow rate - slpm/scfh	
Hot	177 / 376
Cold	201 / 427

Metric

Material Thickness	Torch-to-Work Distance	Initial Pierce Height		Pierce Delay Time	Best Quality Settings		Production Settings	
					Cut Speed	Voltage	Cut Speed	Voltage
mm	mm	mm	%	seconds	(mm/min)	Volts	(mm/min)	Volts
0.5	1.5	3.8	250	0.0	9000	121	12500	119
1					9000	121	10800	119
1.5				0.1	9000	121	10200	120
2					6000	122	9600	120
3				0.4	3250	123	4750	120
4					1900	128	3000	122
6				0.5	700	130	1450	124

English

Material Thickness	Torch-to-Work Distance	Initial Pierce Height		Pierce Delay Time	Best Quality Settings		Production Settings	
					Cut Speed	Voltage	Cut Speed	Voltage
inches	inches	inches	%	seconds	ipm	Volts	ipm	Volts
26GA	0.02	0.08	400	0.0	350	120	500	119
22GA					350	120	450	119
18GA				0.1	350	118	400	119
16GA					350	121	400	120
14GA	0.06	0.15	250	0.2	300	122	400	120
12GA				0.4	150	121	224	120
10GA					100	125	140	121
3/16				0.5	42	131	88	123
1/4				0.6	25	130	48	124

45 A Unshielded cutting (Aluminum)

Air flow rate - slpm/scfh	
Hot	177 / 376
Cold	201 / 427

Metric

Material Thickness	Torch-to-Work Distance	Initial Pierce Height		Pierce Delay Time	Best Quality Settings		Production Settings	
					Cut Speed	Voltage	Cut Speed	Voltage
mm	mm	mm	%	seconds	(mm/min)	Volts	(mm/min)	Volts
1	1.5	3.8	250	0.0	7400	126	11000	121
2				0.1	4400	127	9200	123
3				0.2	2800	129	6250	125
4				0.4	2100	132	4700	126
6				0.5	1050	135	2250	127

English

Material Thickness	Torch-to-Work Distance	Initial Pierce Height		Pierce Delay Time	Best Quality Settings		Production Settings	
					Cut Speed	Voltage	Cut Speed	Voltage
inches	inches	inches	%	seconds	ipm	Volts	ipm	Volts
1/32	0.06	0.15	250	0.0	325	126	450	121
1/16				0.1	200	126	400	122
3/32				0.2	150	127	328	124
1/8				0.4	100	130	224	125
1/4				0.5	36	136	72	127

Section 7

MECHANIZED CUTTING

In this section:

Connecting an optional remote-start pendant	7-2
Connecting an optional machine interface cable	7-3
Machine interface pinout	7-5
Setting the five-position voltage divider	7-6
Connecting an optional RS485 serial interface cable	7-7
Using the machine torch	7-8
Setting up the torch and table	7-8
Understand and optimize cut quality	7-8
Cut or bevel angle	7-8
Dross	7-9
Piercing a workpiece using the machine torch	7-10
Common machine-cutting faults	7-11

Connecting an optional remote-start pendant

Powermax105 configurations with a Duramax machine torch can include an optional remote-start pendant.

- Part number 128650: 7.6 m (25 feet)
- Part number 128651: 15.2 m (50 feet)
- Part number 128652: 22.9 m (75 feet)

If your power supply has the optional machine interface receptacle on the rear of the power supply, remove the receptacle cover and plug the Hypertherm remote-start pendant into the receptacle.

Note: The remote-start pendant is for use only with a machine torch. It will not operate if a handheld torch is installed.

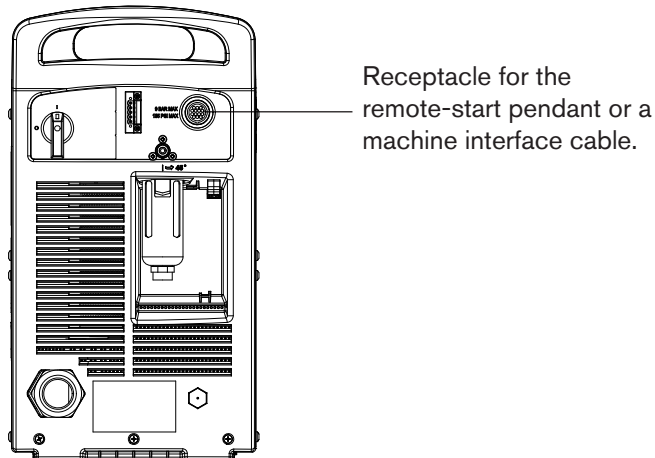

Connecting an optional machine interface cable

The Powermax power supply may be equipped with a factory-installed (or user-installed) five-position voltage divider board. The built-in voltage divider provides a scaled down arc voltage of 20:1, 21.1:1, 30:1, 40:1, or 50:1 (maximum output of 15 V). An optional receptacle on the rear of the power supply (see the previous page) provides access to the scaled down arc voltage and signals for arc transfer and plasma start.

Note: The factory presets the voltage divider to 50:1. To change the voltage divider to a different setting, refer to page 7-6 *Setting the five-position voltage divider*.



Caution: The factory-installed internal voltage divider provides a maximum of 15 V under open circuit conditions. This is an impedance-protected functional extra low voltage (ELV) output to prevent shock, energy, and fire under normal conditions at the machine interface receptacle and under single fault conditions with the machine interface wiring. The voltage divider is not fault tolerant and ELV outputs do not comply with safety extra low voltage (SELV) requirements for direct connection to computer products.

Hypertherm offers several choices of machine interface cables for the Powermax105:

- To use the built-in voltage divider that provides a scaled down arc voltage in addition to signals for arc transfer and plasma start:
 - Use part number 228350 (7.6 m, 25 feet) or 228351 (15.2 m, 50 feet) for wires terminated with spade connectors.
 - Use part number 123896 (15.2 m, 50 feet) for a cable terminated with a D-sub connector. (Compatible with Hypertherm products, such as Edge[®] Ti and Sensor[™] PHC.)
- To use signals for arc transfer and plasma start only, use either part number 023206 (7.6 m, 25 feet) or part number 023279 (15.2 m, 50 feet). These cables have spade connectors as shown below.

Refer to page 7-5 *Machine interface pinout* for receptacle pinout information.

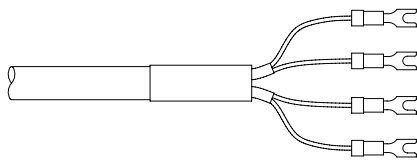

MECHANIZED CUTTING

Note: The cover on the machine interface receptacle prevents dust and moisture from damaging the receptacle when not in use. This cover should be replaced if damaged or lost (part number 127204).

See the *Parts* section for more information.

Installation of the machine interface cable must be performed by a qualified service technician. To install a machine interface cable:

1. Turn OFF the power and disconnect the power cord.
2. Remove the machine interface receptacle's cover from the rear of the power supply.
3. Connect the Hypertherm machine interface cable to the power supply.
4. If you are using a cable with a D-sub connector on the other end, plug it into the appropriate pin connector on the torch height controller or CNC. Secure it with the screws on the D-sub connector.

If you are using a cable with wires and spade connectors on the other end, terminate the machine interface cable inside the electrical enclosure of the torch height controller or CNC controller to prevent unauthorized access to the connections after installation. Verify that the connections are correct and that all live parts are enclosed and protected before operating the equipment.

Note: The integration of Hypertherm equipment and customer-supplied equipment including interconnecting cords and cables, if not listed and certified as a system, is subject to inspection by local authorities at the final installation site.

The connector sockets for each type of signal available through the machine interface cable are shown in the figure on the next page. The table provides details about each signal type.

Machine interface pinout

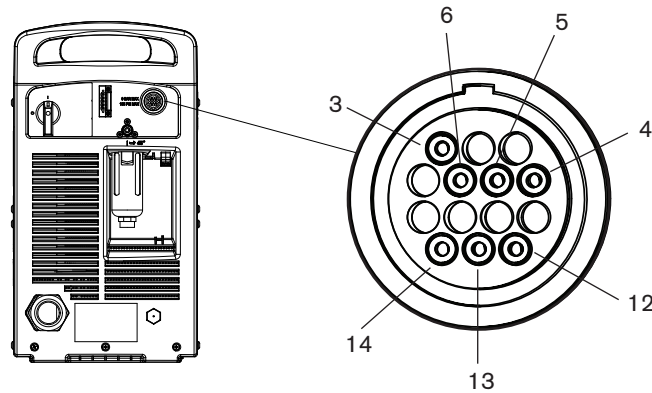

Refer to the following table when connecting the Powermax105 to a torch height controller or CNC controller with a machine interface cable.

Signal	Type	Notes	Connector sockets	Cable wires
Start (start plasma)	Input	Normally open. 18 VDC open circuit voltage at START terminals. Requires dry contact closure to activate.	3, 4	Green, black
Transfer (start machine motion)	Output	Normally open. Dry contact closure when the arc transfers. 120 VAC/1 A maximum at the machine interface relay.	12, 14	Red, black
Ground	Ground		13	
Voltage divider	Output	Divided arc signal of 20:1, 21.1:1, 30:1, 40:1, 50:1 (provides a maximum of 15 V).	5 (-), 6 (+)	Black (-), white (+)

MECHANIZED CUTTING

Setting the five-position voltage divider

To change the factory preset voltage divider from 50:1 to a different setting:

1. Turn OFF the power supply and disconnect the power cord.
2. Remove the power supply cover.
3. Locate the voltage divider DIP switches on the left side of the power supply.

Note: The figure below shows the default setting (50:1) with the number 4 switch up.

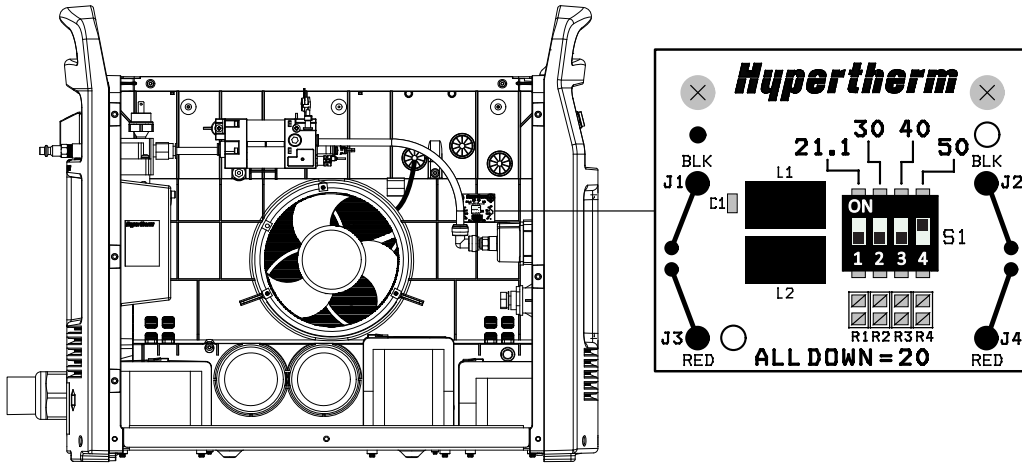

4. Set the DIP switches to one of the following settings and replace the power supply cover.

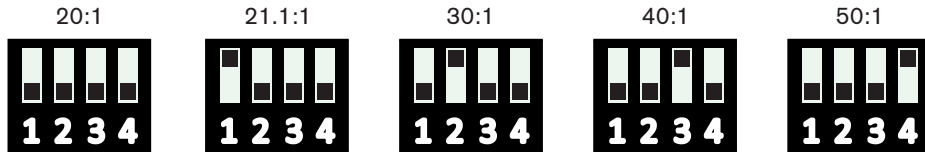

If the Hypertherm five-position voltage divider does not supply the required voltage for your application, contact your system integrator for assistance.

Connecting an optional RS485 serial interface cable

The RS485 serial interface connector on the back of the power supply allows you to connect an external device to your Powermax. For example, you can remotely operate the Powermax with a CNC controller.

The Powermax power supply must be equipped with a factory-installed (or user-installed) RS485 serial interface connector on the rear panel. The receptacle on the rear of the power supply provides access to the RS485 board inside the power supply.

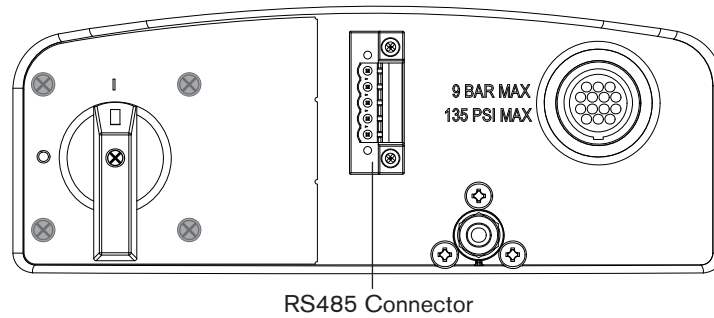

If your power supply is not equipped with the RS485 connector, order kit 228539, "Powermax65/85/105 RS485 board with cables". Follow the installation instructions in the *Power Supply Component Replacement* section of the Service Manual. You can download the Service Manual at www.hypertherm.com ("Downloads library" link).

With the RS485 connector installed:

1. Shut off the power supply.
2. Connect the RS485 cable from your external device to the receptacle on the back of the Powermax power supply.

Using the machine torch

Since the Powermax with a machine torch can be used with a wide variety of cutting tables, track burners, pipe bevelers, and so on, you will need to refer to the manufacturer's instructions for specifics on operating the machine torch in your configuration. However, the information in the following sections will help you optimize cut quality and maximize consumable life.

Setting up the torch and table

- Use a square to align the torch at right angles to the workpiece in two dimensions.
- The torch may travel more smoothly if you clean, check and “tune” the cutting table's rails and drive system. Unsteady machine motion can cause a regular, wavy pattern on the cut surface.
- Ensure that the torch does not touch the workpiece during cutting. Contact with the workpiece can damage the shield and nozzle and affect the cut surface.

Understand and optimize cut quality

There are several factors to consider in cut quality:

- Cut angle — The degree of angularity of the cut edge.
- Dross — The molten material that solidifies on the top or bottom of the workpiece.
- Straightness of the cut surface — The cut surface can be concave or convex.

The following sections explain how these factors can affect cut quality.

Cut or bevel angle

- A positive cut angle, or bevel, results when more material is removed from the top of the cut than from the bottom.
- A negative cut angle results when more material is removed from the bottom of the cut.

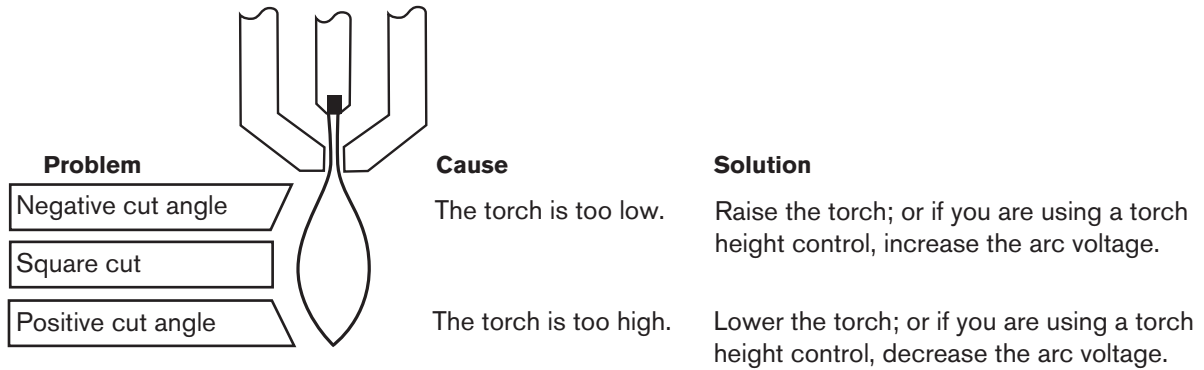

Note: The squarest cut angle will be on the *right* side with respect to the forward motion of the torch. The left side will always have some degree of bevel.

To determine whether a cut-angle problem is being caused by the plasma system or the drive system, make a test cut and measure the angle of each side. Next, rotate the torch 90° in its holder and repeat the process. If the angles are the same in both tests, the problem is in the drive system.

If a cut-angle problem persists after “mechanical causes” have been eliminated (see page 7-8 *Setting up the torch and table*), check the torch-to-work distance, especially if the cut angles are all positive or all negative. Also consider the material being cut: if the metal is magnetized or hardened, you are more likely to experience cut angle problems.

Dross

Some amount of dross will always be present when cutting with air plasma. However, you can minimize the amount and type of dross by adjusting your system correctly for your application.

Excess dross appears on the top edge of both pieces of the plate when the torch is too low (or voltage is too low when using a torch height control). Adjust the torch or adjust the voltage in small increments (5 volts or less) until the dross is reduced.

Low-speed dross forms when the torch's cutting speed is too slow and the arc angles ahead. It forms as a heavy, bubbly deposit at the bottom of the cut and can be removed easily. Increase the speed to reduce this type of dross.

High-speed dross forms when the cutting speed is too fast and the arc angles behind. It forms as a thin, linear bead of solid metal attached very close to the cut. It is more firmly attached to the bottom of the cut than at low speed and is difficult to remove. To reduce high-speed dross:

- Decrease the cutting speed.
- Decrease the torch-to-work distance.

Piercing a workpiece using the machine torch

As with the hand torch, you can start a cut with the machine torch at the edge of the workpiece or by piercing the workpiece. Piercing may result in a shorter consumable life than with edge starts.

The cut charts include a column for the recommended torch height when starting a pierce. For the Powermax105, the pierce height is generally 2.5 times the cutting height. Refer to the cut charts for specifics.

The pierce delay must be long enough that the arc can pierce the material before the torch moves, but not so long that the arc “wanders” while trying to find the edge of a large hole. As consumables wear, this delay time may need to be increased. Pierce delay times given in the cut charts are based on average delay times throughout the life of the consumables.

When piercing materials close to the maximum thickness for a specific process, consider the following important factors:

- Allow a lead-in distance approximately equal to the thickness of the material being pierced. For example, 20 mm (3/4 in) material requires a 20 mm lead-in.
- To avoid damage to the shield from the buildup of molten material created by the pierce, do not allow the torch to descend to cut height until it has cleared the puddle of molten material.
- Different material chemistries can have an adverse effect on the pierce capability of the system. In particular, high-strength steel with a high manganese or silicon content can reduce the maximum pierce capability. Hypertherm derives mild steel parameters using certified A-36 plate.

Common machine-cutting faults

The torch's pilot arc will initiate, but will not transfer. Causes can be:

- The work cable is not making good contact with the cutting table or the cutting table is not making good contact with the workpiece.
- The torch-to-work distance is too large.

The workpiece is not totally penetrated, and there is excessive sparking on the top of the workpiece. Causes can be:

- The metal surface is not clean of rust or paint.
- The consumables are worn and need to be replaced. For optimized performance in a mechanized application, replace the nozzle and the electrode together.
- The work cable is not making good contact with the cutting table or the cutting table is not making good contact with the workpiece.
- The current (amperage) is set too low. See the *Machine Torch Setup* section.
- The cut speed is too high. See the cut charts in the *Machine Torch Setup* section.
- The metal being cut exceeds the maximum capacity for the selected amperage. See the *Specifications* section.

Dross forms on the bottom of the cut. Causes can be:

- The gas setting is incorrect.
- The consumables are worn and need to be replaced. For optimized performance in a mechanized application, replace the nozzle and the electrode together.
- The cutting speed is not correct. See the cut charts in the *Machine Torch Setup* section.
- The current (amperage) is set too low. See the cut charts in the *Machine Torch Setup* section.

The cut angle is not square. Causes can be:

- The torch is not square to the work piece.
- The gas setting is incorrect.
- The consumables are worn and need to be replaced. For optimized performance in a mechanized application, replace the nozzle and the electrode together.
- The direction of the torch travel is incorrect. The high-quality cut is always on the right with respect to the forward motion of the torch.
- The distance between the torch and the workpiece is not correct.
- The cutting speed is not correct. See the cut charts in the *Machine Torch Setup* section.

MECHANIZED CUTTING

The consumable life is shortened. Causes can be:

- The gas setting is incorrect.
- The arc current, arc voltage, travel speed, and other variables are not set as recommended in the cut charts.
- Firing the arc in the air (beginning or ending the cut off of the plate surface). Starting at the edge is acceptable as long as the arc makes contact with the workpiece when started.
- Starting a pierce with an incorrect torch height. Refer to the cut charts for the specific initial pierce height.
- The pierce time is incorrect.
- The air quality is poor (oil or water in the air).
- There might be a faulty pilot arc IGBT which can shorten nozzle life (refer to the troubleshooting sections in this manual, or call Technical Service).



Section 8

MAINTENANCE AND REPAIR

In this section:

Perform routine maintenance	8-2
Inspect the consumables	8-3
Basic troubleshooting.....	8-4
Fault codes and solutions	8-6
Replace the gas filter element	8-9

Perform routine maintenance

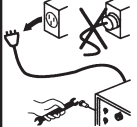
		DANGER ELECTRIC SHOCK CAN KILL
	Disconnect the electrical power before you perform any maintenance. All work that requires removal of the power supply cover must be performed by a qualified technician.	

Every use:

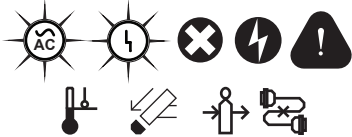

Check indicator lights and fault icons.
Correct any fault conditions.

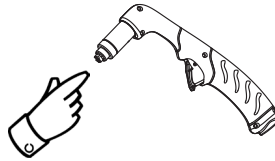

Inspect the consumables for proper installation and wear.

Every 3 months:



Replace any damaged labels.

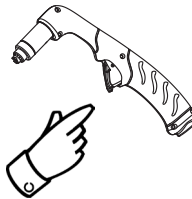

Inspect the trigger for damage. Inspect the torch body for cracks and exposed wires. Replace any damaged parts.



Inspect the power cord and plug. Replace if damaged.

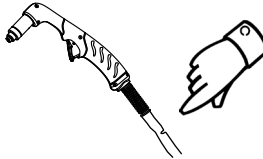



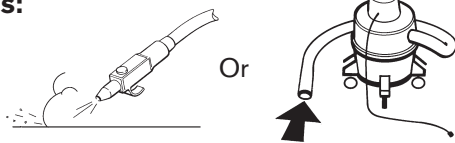

Inspect the torch lead.
Replace if damaged.

Every 6 months:

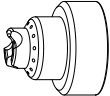

Clean the inside of the power supply with compressed air or a vacuum.

Inspect the consumables

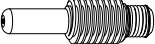
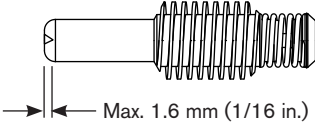
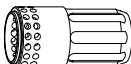
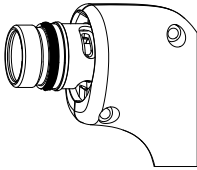
Part		Inspect	Action
	Shield or deflector	The center hole for roundness. The gap between the shield and the nozzle for accumulated debris.	Replace the shield if the hole is no longer round. Remove the shield and clean away any material.
	Nozzle	The center hole for roundness.  Good  Worn	Replace nozzle if the center hole is not round.
	Electrode	 Max. 1.6 mm (1/16 in.)	Replace electrode if the surface is worn or the pit depth is greater than 1.6 mm (1/16 inch) deep.
	Swirl ring	The surface inside the swirl ring for damage or wear and the gas holes for blockages. The O-ring for damage or wear.	Replace swirl ring if the surface is damaged or worn or any of the gas holes are blocked. If the O-ring is worn or damaged, replace it (058519).
	Torch O-ring	The surface for damage, wear, or a lack of lubrication.	If the O-ring is dry, lubricate it and the threads with a thin layer of silicone lubricant. If the O-ring is worn or damaged, replace it (058519).

Basic troubleshooting

The following table provides an overview of the most common problems that can arise when using the Powermax system and explains how to solve them.

Note: Fault icons and corresponding fault codes appear in the LCD display. Refer to page 8-6 *Fault codes and solutions*.

If a fault occurs while using a generator, turn OFF the power supply, wait 30 to 45 seconds, and turn ON the power supply.

If you are unable to fix the problem by following this basic troubleshooting guide, or if you need further assistance:

1. Call your Hypertherm distributor or authorized Hypertherm repair facility.
2. Call the nearest Hypertherm office listed in the front of this manual.







Problem	Solutions
The ON/OFF power switch is set to ON (I), but the power ON LED is not illuminated.	<ul style="list-style-type: none">▪ Verify that the power cord is plugged into the receptacle.▪ Verify that the power is ON at the main power panel or at the line-disconnect switch box.▪ Verify that the line voltage is not too low (more than 15% below the rated voltage).▪ Verify that the fuses in the disconnect are not blown.
The arc does not transfer to the workpiece.	<ul style="list-style-type: none">▪ Clean the area where the work clamp contacts the workpiece to ensure a good metal-to-metal connection.▪ Inspect the work clamp for damage and repair as necessary.▪ The pierce-height distance may be too large. Move the torch closer to the workpiece and fire the torch again.





Problem	Solutions
The arc blows out, but re-ignites when the torch trigger is pressed again.	<ul style="list-style-type: none">▪ Inspect the consumable parts and replace them if they are worn or damaged. See page 8-3 <i>Inspect the consumables</i>.▪ Replace the gas filter's element if it is contaminated. See page 8-9 <i>Replace the gas filter element</i>.▪ Make sure the gas pressure is at the proper level.
The arc sputters and hisses.	<ul style="list-style-type: none">▪ The gas filter's element is contaminated. Replace the element. See page 8-9 <i>Replace the gas filter element</i>.▪ Inspect the gas line for moisture. If necessary, install or repair the gas filtration to the power supply. See the, <i>Power Supply Setup</i>, section.
The cut quality is poor.	<ul style="list-style-type: none">▪ Verify that the torch is being used correctly. See the <i>Basic System Operations, Hand Cutting, or Mechanized Cutting</i> section.▪ Inspect the consumables for wear and replace as necessary. See 8-3 <i>Inspect the consumables</i>.▪ Check the air pressure and air quality.▪ Verify that the cutting mode switch is in the proper position for the cutting operation.▪ Verify that the correct consumables are installed.

Fault codes and solutions





A label with descriptions for these common fault codes can be found inside the front cover of this manual. Peel off the label and place it on the rear of the power supply for reference.

Note: If a fault occurs while using a generator, turning the power switch quickly to OFF and then to ON again (sometimes called a “quick reset” or “quick restart”) may not clear the fault. Instead, turn OFF the power supply and wait 30 to 45 seconds before turning ON again.

Fault code	Description	Power LED	Fault LED	Fault icon	Solutions
0-12	Low input gas pressure or unstable gas pressure: Warning (the system continues to operate)	On	Off		<ul style="list-style-type: none"> Adjust the gas inlet pressure as needed.
0-13	AC input unstable: Warning (the system continues to operate)	Blinks (3 Hz)	Off		<ul style="list-style-type: none"> Correct the power source.
0-19	Power board hardware protection. One or more power board hardware faults (or noise) detected.	On	On		<p>The inverter shuts down and does not fire again for several seconds. If the fault is caused by electrical noise, the fault clears in a few seconds and the machine operates normally.</p> <p>A true 0-19 fault may display for up to 60 seconds before fault code 0-99 displays on the operator screen. A qualified service technician must service the system. Contact your distributor or authorized repair facility.</p>
0-20	Low gas pressure	On	On		<ul style="list-style-type: none"> Check the input gas supply. Adjust the gas pressure to the acceptable range using Manual mode. See the <i>Basic System Operations</i> section. Perform a quick restart.
0-21	Gas flow lost while cutting	On	On		<ul style="list-style-type: none"> Restore the gas inlet pressure and restart the power supply. Check the torch lead for leaks or kinking. Change consumables.
0-22	No gas input	On	On		<ul style="list-style-type: none"> Connect the gas source and restart the power supply.

Fault code	Description	Power LED	Fault LED	Fault icon	Solutions
0-30	Torch consumables stuck This indicates either a "torch stuck open" or a "torch stuck closed" situation.	On	On		<ul style="list-style-type: none"> ▪ If the consumables became loose or were removed while the power supply is ON, turn OFF the power supply, correct the problem and then turn ON the power supply to clear this fault. ▪ Change consumables. ▪ If the consumables appear to be installed correctly, the torch may be damaged. Contact your Hypertherm distributor or authorized repair facility.
0-32	End of consumable life	On	On		<ul style="list-style-type: none"> ▪ Replace the electrode and nozzle. ▪ Check the remaining consumables for wear and replace as needed.
0-40	Over/under temperature	On	On		<ul style="list-style-type: none"> ▪ Leave the power supply on to allow the fan to cool the power supply. ▪ If the internal temperature of the power supply approaches -30° C (-22° F), move the power supply to a warmer location.
0-50	Retaining cap off	On	On		<ul style="list-style-type: none"> ▪ Turn OFF the power supply. Verify that the consumables are installed and restart the power supply. ▪ If the consumables appear to be installed correctly, the torch may be damaged. Contact your Hypertherm distributor or authorized repair facility.
0-51	Start/trigger signal on at power up This situation indicates that the power supply is receiving a start signal. It is sometimes referred to as a "stuck start."	On	On		<ul style="list-style-type: none"> ▪ If the power supply is turned on while the torch trigger is pressed, the system is disabled. Release the trigger and recycle the power switch.

MAINTENANCE AND REPAIR

Fault code	Description	Power LED	Fault LED	Fault icon	Solutions
0-52	Torch not connected	On	On		<ul style="list-style-type: none"> Plug a torch lead into the FastConnect receptacle on the front of the power supply and recycle the power switch.
0-60	AC input voltage error	On	On	 AC	<ul style="list-style-type: none"> Phase loss: Check all input phases and fuses. Over voltage: Check the line, decrease the voltage. Under voltage: Check the line, increase the voltage.
0-61	AC input unstable: Shutdown	On	On		<ul style="list-style-type: none"> The incoming line current is unstable. Power down and correct the line problem before continuing.
0-98	Internal communication failure	On	On		<ul style="list-style-type: none"> Power down, wait 20 seconds, power up. A qualified service technician must open the power supply case and check the ribbon cable between the control board and the DSP board.
0-99	System hardware fault — service required Indicates a major fault with the system.	On	On		<ul style="list-style-type: none"> A qualified service technician must service the system. Contact your distributor or authorized repair facility.

Replace the gas filter element

1. Turn OFF the power, disconnect the power cord, and make sure the gas supply is disconnected.
2. Position the rear of the power supply so the removable gas filter bowl is easily accessible.
3. Grasp the filter bowl with your right hand.
4. Push down the thumb latch and rotate the filter bowl approximately 45 degrees to the right.
5. Pull the filter bowl straight down to remove. You can see the white filter element and retaining nut.
6. Unscrew (counterclockwise) the plastic retaining nut that secures the filter element.
7. Replace the dirty element with a new element. Reinstall (clockwise) the plastic retaining nut to finger-tight only.
8. Insert the filter bowl with the thumb latch positioned approximately 45 degrees to the right of center. This is the same orientation in which the filter bowl was pulled down and removed.
9. Vertically align the filter bowl (with metal guard) and firmly push the filter bowl up to the top of the receptacle to seat the bowl. It is helpful to lift the bowl with your left index finger under the nut on the bottom of the bowl.
10. Once the bowl is seated properly, rotate the bowl 45 degrees to the left until you hear the thumb latch click into place.
11. Reconnect the gas supply hose to the power supply and check for leaks.
12. Reconnect the electrical power and turn ON the power switch.

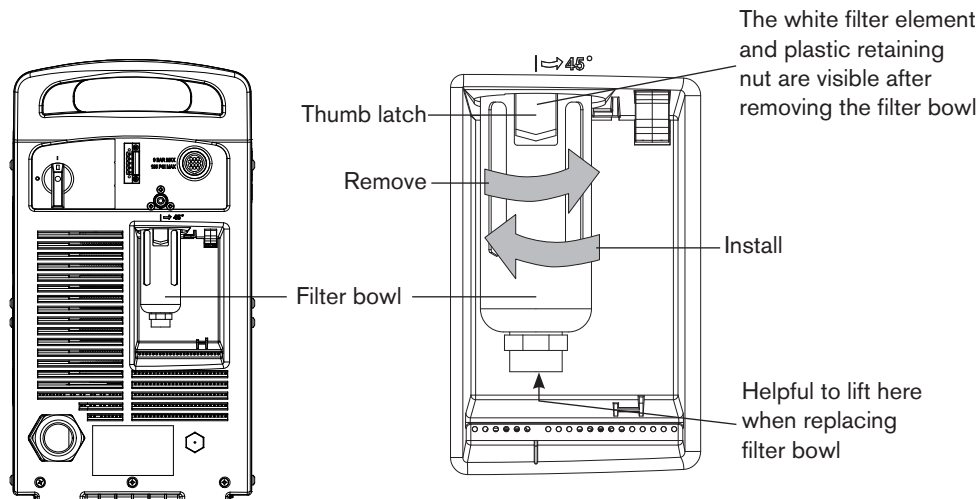

Section 9

PARTS

In this section:

Power supply parts.....	9-2
Duramax 75° hand torch replacement parts.....	9-6
Duramax 15° hand torch replacement parts.....	9-7
Hand torch consumables.....	9-8
Duramax 180° full-length machine torch replacement parts	9-9
Duramax 180° mini machine torch replacement parts	9-11
Machine torch consumables	9-13
Accessory parts.....	9-14
Powermax105 labels.....	9-15

Power supply parts

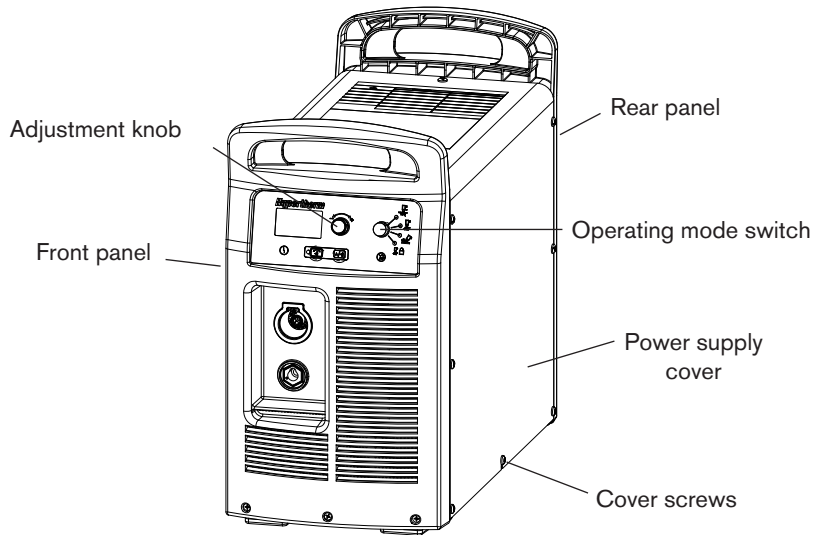

Part number	Description
228866	Kit: Powermax105 front panel
228867	Kit: Powermax105 200-600V CSA rear panel
228868	Kit: Powermax105 230-400V CE rear panel
228869	Kit: Powermax105 400V CE/380V CCC rear panel
228905	Kit: Powermax105 CSA power supply cover with labels
228906	Kit: Powermax105 CE/CCC power supply cover with labels
108797	Adjustment knob
108732	Operating mode switch
075769	Cover screws

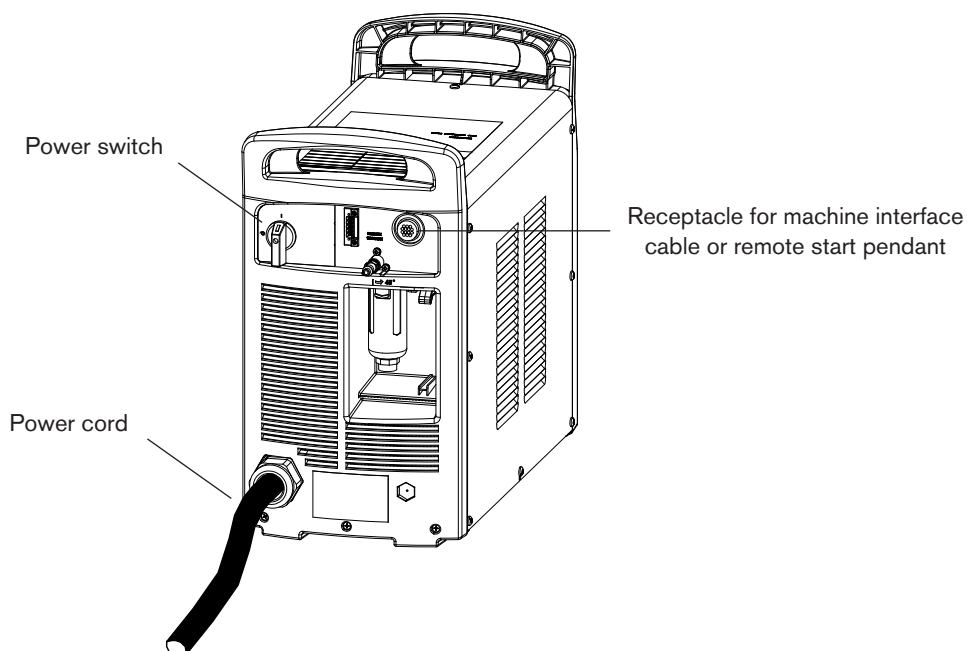

Part number	Description
228885	Kit: Powermax105 power cord 200-600V CSA
228886	Kit: Powermax105 power cord 230-400V CE
228887	Kit: Powermax105 power cord 400V CE
228962	Kit: Powermax105 power cord 380V CCC
228913	Kit: Powermax105 power cord strain relief 230-400V CE
228914	Kit: Powermax105 power cord strain relief 400V CE/380V CCC
228915	Kit: Powermax105 power cord strain relief CSA
128650	Remote start pendant for machine torch, 7.6 m (25 ft)
128651	Remote start pendant for machine torch, 15.2 m (50 ft)
128652	Remote start pendant for machine torch, 22.9 m (75 ft)

See next page for machine interface cables.

PARTS

Part number	Description
023206	Machine interface cable (start plasma, arc transfer, ground), 7.6 m (25 ft), spade connectors
023279	Machine interface cable (start plasma, arc transfer, ground), 15.2 m (50 ft), spade connectors
228350	Machine interface cable (start plasma, arc transfer, adjustable voltage divider, ground), 7.6 m (25 ft), spade connectors
228351	Machine interface cable (start plasma, arc transfer, adjustable voltage divider, ground), 15.2 m (50 ft), spade connectors
127204	Cover for Powermax45/65/85/105 machine interface (CPC) receptacle
228539	Kit: Powermax65/85/105 RS485 board with cables
228884	Kit: Powermax105 machine interface cable, internal cable with voltage divider board (CPC port upgrade)
123896	Machine interface cable (start, stop, transfer signals), 15.2 m (50 ft), D-sub connector with screws

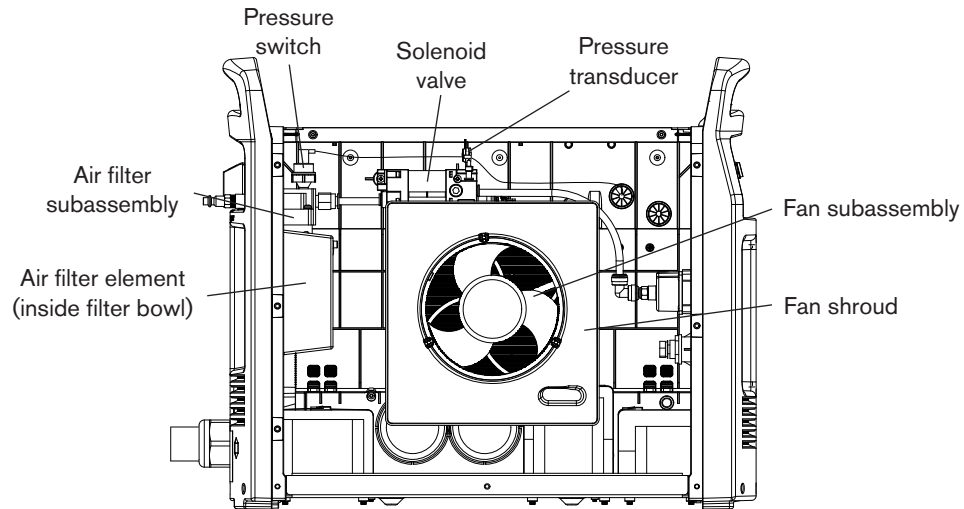

Part number	Description
228881	Kit: Powermax105 fan subassembly
228910	Kit: Powermax105 fan shroud
228685	Kit: Powermax65/85/105 air filter subassembly
228695	Kit: Powermax65/85/105 air filter element
228688	Kit: Powermax65/85/105 pressure switch
228882	Kit: Powermax105 regulator/solenoid valve
228689	Kit: Powermax65/85/105 pressure transducer

Duramax 75° hand torch replacement parts

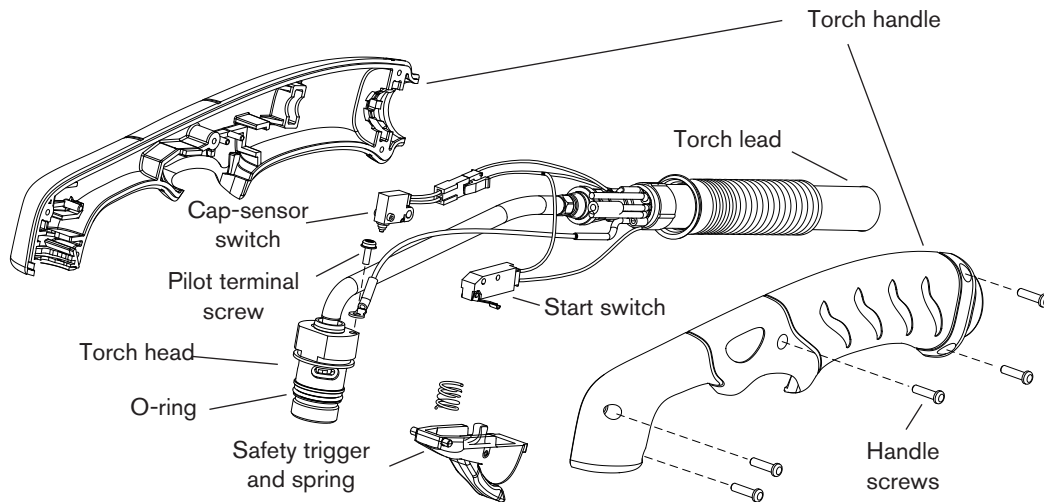

The entire hand torch and lead assembly can be replaced, or individual component parts can be replaced. Part numbers starting with 059 indicate complete torch and lead assemblies.

Part number	Description
059473*	Powermax65/85/105 75° hand torch assembly with 7.6 m (25 ft) lead
059474*	Powermax65/85/105 75° hand torch assembly with 15.2 m (50 ft) lead
059475*	Powermax65/85/105 75° hand torch assembly with 22.9 m (75 ft) lead
228954	Kit: Duramax 75°/HRT torch handle replacement
075714	Handle screws, #4 x 1/2 slotted TORX pan head
228721	Kit: Duramax 75°/15° hand torch safety trigger with spring replacement
228958	Kit: Duramax 75° hand torch main body replacement
058519	O-ring
075504	Pilot terminal screw
228719	Kit: Duramax 75° hand torch cap-sensor switch replacement
228959	Kit: Duramax hand torch lead replacement, 7.6 m (25 ft)
228960	Kit: Duramax hand torch lead replacement, 15.2 m (50 ft)
228961	Kit: Duramax hand torch lead replacement, 22.9 m (75 ft)
128642	Kit: Start switch replacement
228314	Kit: Powermax45/65/85/105 torch quick disconnect repair (latch & spring)

* The torch assembly does not include consumables. See page 9-8 for a list of consumable part numbers.

Duramax 15° hand torch replacement parts

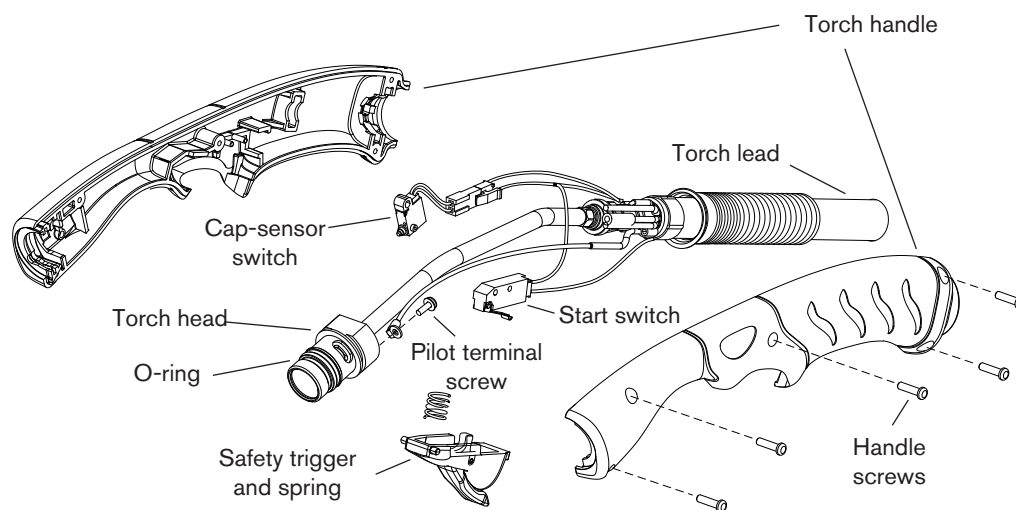

The entire hand torch and lead assembly can be replaced, or individual component parts can be replaced. Part numbers starting with 059 indicate complete torch and lead assemblies.

Part number	Description
059470*	Powermax65/85/105 15° hand torch assembly with 7.6 m (25 ft) lead
059471*	Powermax65/85/105 15° hand torch assembly with 15.2 m (50 ft) lead
059472*	Powermax65/85/105 15° hand torch assembly with 22.9 m (75 ft) lead
228955	Kit: Duramax 15°/HRTs torch handle replacement
075714	Handle screws, #4 x 1/2 slotted TORX pan head
228721	Kit: Duramax 75°/15° hand torch safety trigger with spring replacement
228957	Kit: Duramax 15° hand torch main body replacement
058519	O-ring
075504	Pilot terminal screw
228109	Kit: Powermax30/45/65/85/105 15° hand torch/T30v/T45v/HRTs cap-sensor switch replacement
228959	Kit: Duramax hand torch lead replacement, 7.6 m (25 ft)
228960	Kit: Duramax hand torch lead replacement, 15.2 m (50 ft)
228961	Kit: Duramax hand torch lead replacement, 22.9 m (75 ft)
128642	Kit: Start switch replacement
228314	Kit: Powermax45/65/85/105 torch quick disconnect repair (latch & spring)

* The torch assembly does not include consumables. See page 9-8 for a list of consumable part numbers.

Hand torch consumables

Part number	Description
Drag cutting	
220818	Shield 45/65/85 A
220992	Shield 105 A
220854	Retaining cap
220941	Nozzle 45 A
220819	Nozzle 65 A
220816	Nozzle 85 A
220990	Nozzle 105 A
220842	Electrode
220994	Swirl ring
220947	Swirl ring
Gouging	
220798	Shield
220854	Retaining cap
220991	Nozzle 105 A
220842	Electrode
220994	Swirl ring
FineCut	
220931	Deflector
220854	Retaining cap
220930	Nozzle
220842	Electrode
220947	Swirl ring

Duramax 180° full-length machine torch replacement parts

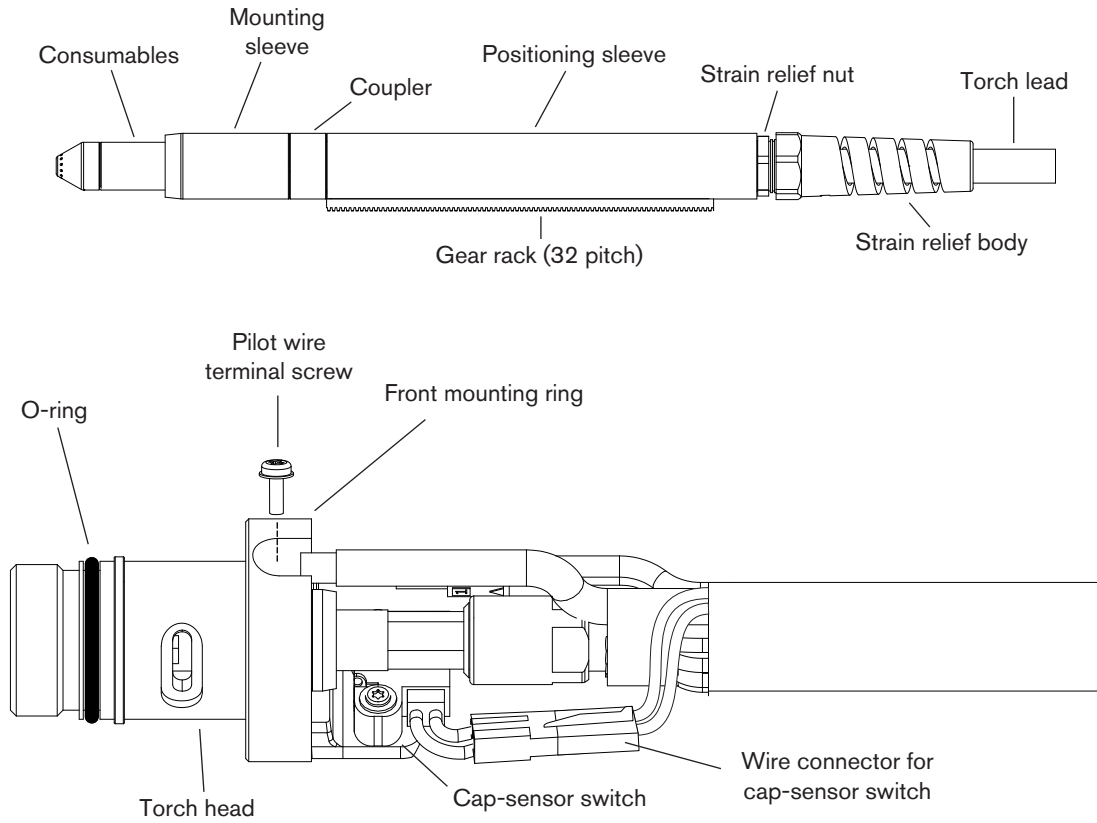

PARTS

The entire machine torch and lead assembly can be replaced, or individual component parts can be replaced. Part numbers starting with 059 indicate complete torch and lead assemblies.

Part number	Description
059476*	Powermax65/85/105 180° full-length machine torch assembly with 4.6 m (15 ft) lead
059477*	Powermax65/85/105 180° full-length machine torch assembly with 7.6 m (25 ft) lead
059478*	Powermax65/85/105 180° full-length machine torch assembly with 10.7 m (35 ft) lead
059479*	Powermax65/85/105 180° full-length machine torch assembly with 15.2 m (50 ft) lead
059480*	Powermax65/85/105 180° full-length machine torch assembly with 22.9 m (75 ft) lead
228737	Kit: Powermax65/85/105 180° full-length machine torch/MRT positioning sleeve
228738	Kit: Powermax65/85/105 180° full-length machine torch/MRT removable gear rack replacement
228735	Kit: Powermax65/85/105 180° full-length/mini machine torch/MRT front mounting sleeve
228736	Kit: Powermax65/85/105 180° full-length/mini machine torch/MRT adapter ring (coupler)
228716	Kit: Powermax65/85/105 180° full-length/mini machine torch main body replacement
228720	Kit: Powermax65/85/105 180° full-length/mini machine torch/MRT cap-sensor switch replacement
058519	O-ring
075504	Pilot terminal screw
228730	Kit: Powermax65/85/105 180° full-length/mini machine torch lead replacement, 4.6 m (15 ft)
228731	Kit: Powermax65/85/105 180° full-length/mini machine torch lead replacement, 7.6 m (25 ft)
228732	Kit: Powermax65/85/105 180° full-length/mini machine torch lead replacement, 10.7 m (35 ft)
228733	Kit: Powermax65/85/105 180° full-length/mini machine torch lead replacement, 15.2 m (50 ft)
228734	Kit: Powermax65/85/105 180° full-length/mini machine torch lead replacement, 22.9 m (75 ft)
228314	Kit: Powermax45/65/85/105 torch quick disconnect repair (latch & spring)

* The torch assembly does not include consumables. See page 9-13 for a list of consumable part numbers.

Duramax 180° mini machine torch replacement parts

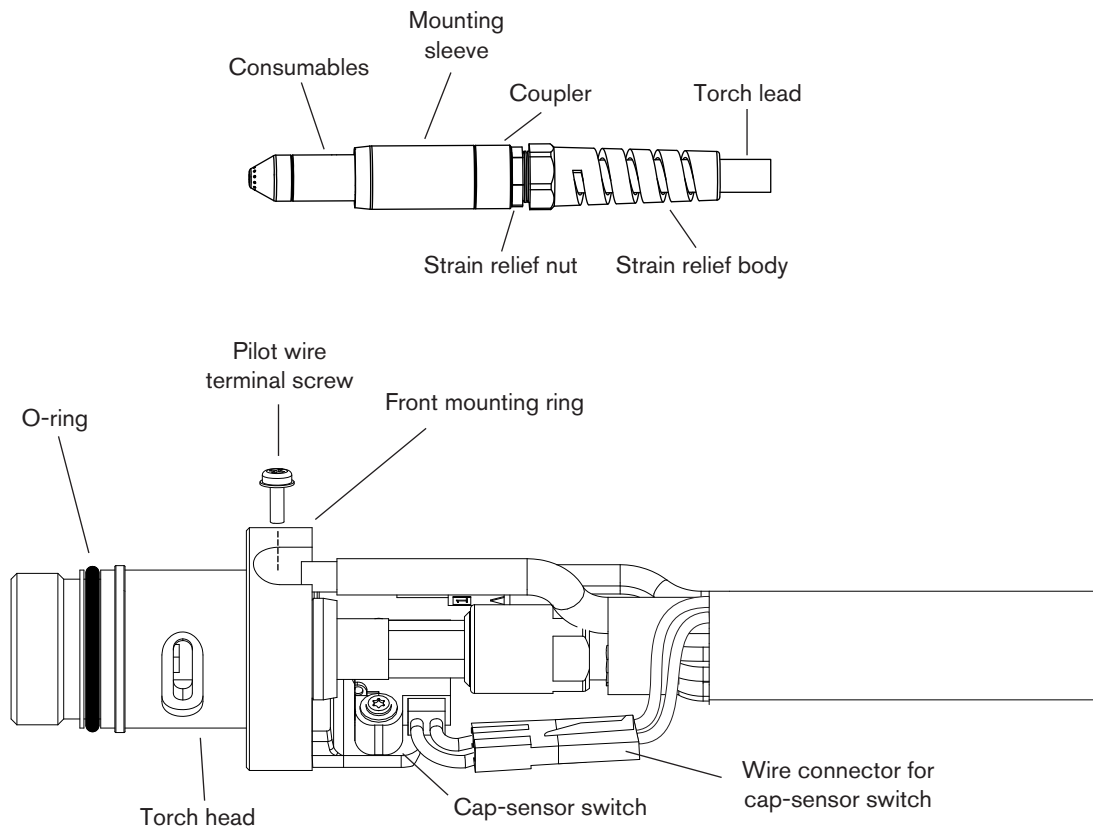

PARTS

The entire machine torch and lead assembly can be replaced, or individual component parts can be replaced. Part numbers starting with 059 indicate complete torch and lead assemblies.

Part number	Description
059481*	Powermax65/85/105 180° mini machine torch assembly with 4.6 m (15 ft) lead
059482*	Powermax65/85/105 180° mini machine torch assembly with 7.6 m (25 ft) lead
059483*	Powermax65/85/105 180° mini machine torch assembly with 10.7 m (35 ft) lead
059484*	Powermax65/85/105 180° mini machine torch assembly with 15.2 m (50 ft) lead
228735	Kit: Powermax65/85/105 180° full-length/mini machine torch/MRT front mounting sleeve
228736	Kit: Powermax65/85/105 180° full-length/mini machine torch/MRT adapter ring (coupler)
228716	Kit: Powermax65/85/105 180° full-length/mini machine torch main body replacement
228720	Kit: Powermax65/85/105 180° full-length/mini machine torch/MRT cap-sensor switch replacement
058519	O-ring
075504	Pilot terminal screw
228730	Kit: Powermax65/85/105 180° full-length/mini machine torch lead replacement, 4.6 m (15 ft)
228731	Kit: Powermax65/85/105 180° full-length/mini machine torch lead replacement, 7.6 m (25 ft)
228732	Kit: Powermax65/85/105 180° full-length/mini machine torch lead replacement, 10.7 m (35 ft)
228733	Kit: Powermax65/85/105 180° full-length/mini machine torch lead replacement, 15.2 m (50 ft)
228734	Kit: Powermax65/85/105 180° full-length/mini machine torch lead replacement, 22.9 m (75 ft)
228314	Kit: Powermax45/65/85/105 torch quick disconnect repair (latch & spring)

* The torch assembly does not include consumables. See page 9-13 for a list of consumable part numbers.

Machine torch consumables

Part number	Description
Shielded	
220817	Shield 45/65/85 A
220993	Shield 105 A
220854	Retaining cap
220953	Ohmic retaining cap
220941	Nozzle 45 A
220819	Nozzle 65 A
220816	Nozzle 85 A
220990	Nozzle 105 A
220842	Electrode
220994	Swirl ring
Unshielded	
220955	Deflector
220854	Retaining cap
220941	Nozzle 45 A
220819	Nozzle 65 A
220816	Nozzle 85 A
220990	Nozzle 105 A
220842	Electrode
220994	Swirl ring
Gouging	
220798	Shield
220854	Retaining cap
220991	Nozzle 105 A
220842	Electrode
220994	Swirl ring
FineCut*	
220955	Deflector
220948	Shield
220854	Retaining cap
220953	Ohmic retaining cap
220930	Nozzle
220842	Electrode
220994	Swirl ring

*The deflector (220955) is used only with the standard retaining cap (220854).

Accessory parts

Part number	Description
024548	Brown leather torch sheathing, 7.6 m (25 ft)
024877	Black leather torch sheathing with Hypertherm logo, 7.6 m (25 ft)
127102	Basic plasma (circles and lines) cutting guide
027668	Deluxe plasma (circles and lines) cutting guide
127360	Powermax105 dust cover
228695	Kit: Powermax65/85/105 air filter element
228890	Kit: Eliminer air filter with protective metal cover for the Powermax105
101215	Kit: Eliminer air filter protective metal cover for the Powermax105 (cover only)
223254	Kit: 105 A work lead with hand clamp, 7.6 m (25 ft)
223255	Kit: 105 A work lead with hand clamp, 15.2 m (50 ft)
223256	Kit: 105 A work lead with hand clamp, 22.9 m (75 ft)
223287	Kit: 105 A work lead with C-style clamp, 7.6 m (25 ft)
223288	Kit: 105 A work lead with C-style clamp, 15.2 m (50 ft)
223289	Kit: 105 A work lead with C-style clamp, 22.9 m (75 ft)
223284	Kit: 105 A work lead with ring terminal, 7.6 m (25 ft)
223285	Kit: 105 A work lead with ring terminal, 15.2 m (50 ft)
223286	Kit: 105 A work lead with ring terminal, 22.9 m (75 ft)
008337	Ground hand clamp: 300 A
229467	Kit: Powermax105 wheel kit assembly

Powermax105 labels

Part number	Description
228903	Kit: Powermax105 labels, CSA
228904	Kit: Powermax105 labels, CE

The label kits include the consumables label, appropriate safety labels, display panel label, power switch label, and side decals.

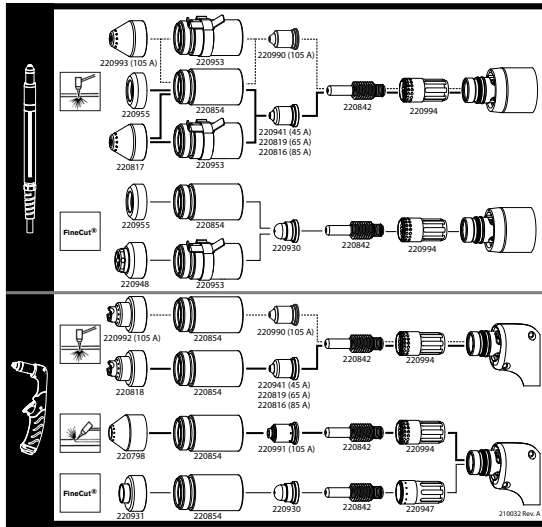

Consumables label



CE safety label

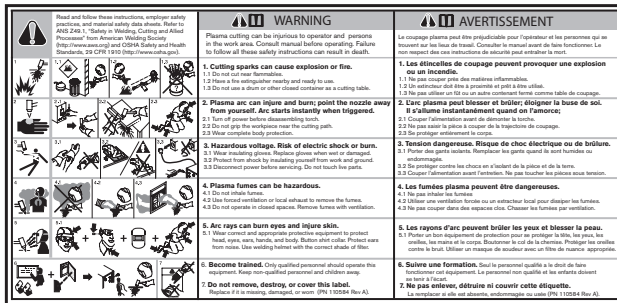

CSA safety label

